

# BACK TO BASICS

---

---

THE BREEDING, MANAGEMENT  
AND CULTURE OF THE CANARY.

---

---



A MUST READ FOR THE BEGINNER.  
A REFRESHER FOR THE EXPERIENCED.

by *JOHN RICE*

1st Printing 1991  
Printed by Copy - Post Chula Vista, Ca  
Published with arrangements by Author

•

Copyright (c ) 1991 John Rice  
All rights Reserved  
Printed in the United States Of America

# BACK TO BASICS

---

---

*by John Rice*



---

---

The text and subject matter written in this book is a recension of notes and original scripts gathered over the years and compiled by the author. Personal experience of breeding canaries for the past sixteen years has also contributed.

Brief excerpts from illustrations and that of original scripts are from a number of sources.

In particularly are:

The Lizard Canary, by G.T. Dodwell.

Encyclopedia Of Canaries, by G.T.Dodwell.

Cage Bird Magazine.

May I Help You Column, by Margie McGee.

Handbook On Canaries, by

Dr. Matthen M. Vriends.

Veterinary Clinical Parasitology, by

Margaret Sloss, Russell Kemp.

The Canary And Finch Journal.

Canaries, by Paul Paradise.

Edited by Marsha Jenkins.

Sketches and Drawings by Loy Rice.

Reviewers:

Wayne Givens.

Erhard Vogel, Ph D.

Dr. Jorge A. Martinez, M.D.

---

---



## Foreword

Human beings have cultivated a dual relationship with animals from prehistoric times to the present. We have related to fellow creatures on this planet as prey to be used for food and other utilitarian purposes, and we have fostered a relationship with some animal species purely for the pleasure of their presence in our lives. Birds have been in this category for thousands of years.

We have cultivated a friendly relationship with falcons, to cite one example, to be our partners in sport; parrots may, due to their longevity, provide lifelong companionship; other birds are kept for beauty of their form, plumage or song. The canary qualifies for the last three mentioned categories.

My own interest in birds began when I grew up in the murderous mayhem of World War II Germany. These fragile creatures who could fly seemed to the small boy so vulnerable amidst all that destruction. My heart went out to them; I wanted to help them and care for them; I was captured by a mysterious fascination. To the boy aching for relief from the horror of carnage, death and destruction, birds represented innocence and beauty.

Many canary breeders are of these beautiful little their sincere purpose is the species. so enamored singers that to perpetuate the species.

My experience with canaries is probably quite similar to that of many others in as much as I started with a single bird for whom I soon procured a mate in order to forestall possible loneliness on the part of the first bird. They did what birds do, and I had to learn how to properly provide and care for my growing responsibilities. Resorting to books as sources of information on the successful breeding and rearing of canaries often proved to be a complex, if not frustrating, task. The books frequently were so obtuse and incomplete as to be unreliable and unhelpful. I soon found that conversation with an experienced breeder could yield a richer flow of information than many hours of research with books.

The first breeder who generously shared his wealth of knowledge with me was John Rice who was then the President of The San Diego County Canary Club. Like many other experienced bird breeders of that organization, John Rice has made it his mission for many years now to allow less experienced breeders, and, by extension, canaries, to benefit from his considerable knowledge.

Most canary breeders eventually search for a compilation of the necessary basic facts regarding the many facets of their specialized interest. Back To Basics is John Rice's answer to this need. John writes in a forthright and unpretentious style on a wide range of topics including aviaries, feeding, diseases, as well as the nut-and-thread method of The book is true

to its title to name a few breeding, mysterious sexing. and presents the facts as John Rice sees them after years of experience.

In 1988, at the annual National Cage Bird Show, held in San Diego, Ca., the dedication and expertise of John Rice were acknowledged and rewarded when he won the prestigious Kellogg Trophy and Scannell Trophy for having the Best Bird In Show, a spectacularly beautiful and healthy Toco Toucan.

May the reader enjoy Back To Basics and benefit from the and knowledge presented in and thereby be better prepared to be of benefit to canaries. wealth of experience this book  
Erhard Vogel, Ph.D.  
El Cajon Ca.



# SECTION ONE

## CONTENTS

History Of The Canary .....	1
Cages For Canaries .....	3
Outside Aviaries .....	5
Diet For Canaries .....	6
Going Light .....	7
Beneficial Seeds .....	8
Pellets .....	8
Breeding Canaries .....	9
Housing Canaries For Breeding ....	12
Breeding Cages .....	12
Separate Hens From Males .....	13
Colony Breeding .....	13
Nests .....	13
Nesting Material .....	14
Building The Nest .....	15
Signs Of Copulation .....	15
Yokers .....	17
Banding the Chicks .....	18
Hand Feeding .....	19
Keeping The Nest Clean .....	20
Chicks Leaving Nest .....	20
Weaning The Chicks .....	21

## HISTORY OF THE CANARY

First a short history of the canary. The credit goes to the Spaniards for the discovery of the canary. Sometime in the 15th century Spanish sailors went ashore on an island off the coast of Africa in the Atlantic Ocean. The Spanish sailors were astonished by the beautiful song coming from a small bird that was green in color with gray brown stripes.

The sailors caught as many as they could and returned to their ship. Upon returning to Spain, their native land, they soon realized that there was a demand for this little bird because of the beautiful song. Each time they returned to the island, they would catch more and more of the birds, return home

and sell them, mostly to the rich people of Spain. The Spaniards would have a monopoly on the canary for years to come.

It was not until sometime in the 16<sup>th</sup> century that the monopoly was broken. A Spanish ship was sailing off the coast of Italy with its holds filled with hundreds of canaries. It ran into a violent storm, wrecking the ship, tearing it apart. The only survivors were the canaries that flew westward to the island of Elba. Elba being an island belonging to Italy, the Italians were free to claim the canary as well.

The Italians sold canaries all over Europe. Massive breeding began for the song bird. Later the canary reached England and then, of course, America.

The ancestry of the canary we have today is colossal. The study of the ancestry has become a profession called Ornithology.

From cross breeding, the most product is the Red-Factor canary. About 85 years ago a German doctor cross bred recent a canary with a Red Siskin introducing the red color. Today this canary is called the Red-Factor canary.

There are many species of canaries. Type canaries were bred for a specific conformation distinguishing them from other types.

Depending on who and what you read, the credit goes to the people and England. Once the conformation was established in these type canaries and recognized by canary authorities, an unwritten oath among the serious breeders was to never cross the breed with other type canaries. Therefore, the conformation would remain as is or improve. Later we will learn more about Type canaries.

Some of the more popular canaries of today for singing in the home, are the color-bred canary, the American Singer, Roller and the Hartz. The color-bred canary has been referred to as the "Kitchen Canary". Maybe it was because the lady of the house spent most of her time in the kitchen and wanted the canary for company.

Years ago, in Europe the coal miners used the canary as a precautionary measure while working deep in in the mines. They would take a canary in a small cage down in the mines and hang the cage in the area where they worked. If the canary died this would tell them there was not enough oxygen to support life. This may

## CAGES FOR CANARIES

sound cruel, but in those days detection devices did not exist.

In my opinion, companies that manufacture cages are more interested in appearance of cages satisfying people than being a cage that is appropriate for a bird to live in. Canaries must have room for Canaries in a very small cage not eat properly. A cage should be big enough to where the perches can be placed at least 18 inches apart or like to fly horizontally, Cages should have a pull-out tray on the bottom for easy should not be tapered that catches defecation. Square or rectangular cages can serve the above.

Cages and perches should be cleaned regularly. After cleaning, cages and perches, let them dry in the sun. Perches should be different in sizes – oval and round. Prefixed sandpaper for the perches should not be used, Prefixed sandpaper for the bottom of the cages should not be used, as it irritates the feet.

## OUTSIDE AVIARIES

Outside aviaries can be any shape or size. Inside, the aviary can be made into several compartments. If you are handy with saw, hammer and nails, you can construct an aviary with flights and a breeding room. You should consider from what direction the wind blows and how the sun will shine on the building.

There must be screens on the windows that will keep mosquitos away from your canaries.

Some mosquitos carry a pox. When canaries sit down on a perch, their feathers do not cover their toes. Mosquitos will drill in between the scales, and if the mosquito is carrying the pox, the canary will be infected. It is called Canary Pox and it can be fatal. The pox is also contagious; left untreated it can spread to all of your birds. Signs to look for are lesions on the feet and around the eyes. If a bird is found with these lesions, they should be isolated from other birds. Only a veterinarian can help with this problem.

The roof of an outside aviary should not be open where defecation from wild birds can fall into the aviary. Wild birds may carry diseases. Nontoxic paint should be used for the inside. Wood shavings can cover the bottom; they are easy to dispose of. An exhaust fan can be placed in the roof. Canaries can take cooler weather better than the hot weather. Do not waste your time planting plants or small trees, canaries will just eat them.

Depending in what part of the country you live will determine what kind of building you need. In cold climate you may have to insulate in the heated portion of the aviary. In mild weather insulation may not be required. When breeding canaries, which we will get into later, you will have to have heat, lighting and running water. You may want to consider just a summer home for your canaries. Breeding can be done in your house. More on breeding later. Of course, cats, mice and other animals have to be dealt with outside.

## OUTSIDE AVIARIES

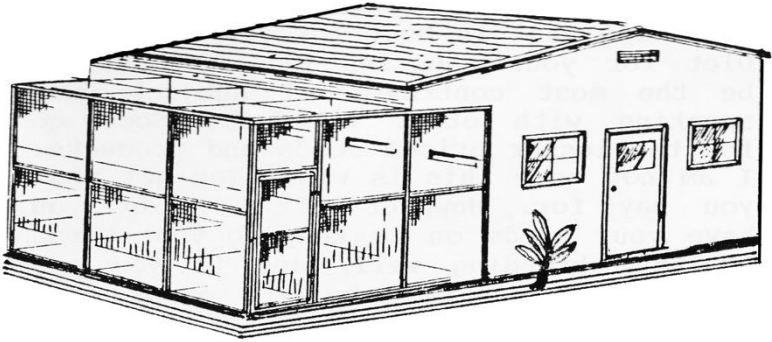

This outside flights. Heating, room can be the other, indoor-outdoor aviary is constructed with lighting and a breeding in one portion, flights in The result is an all- weather, aviary. A smaller outside can also

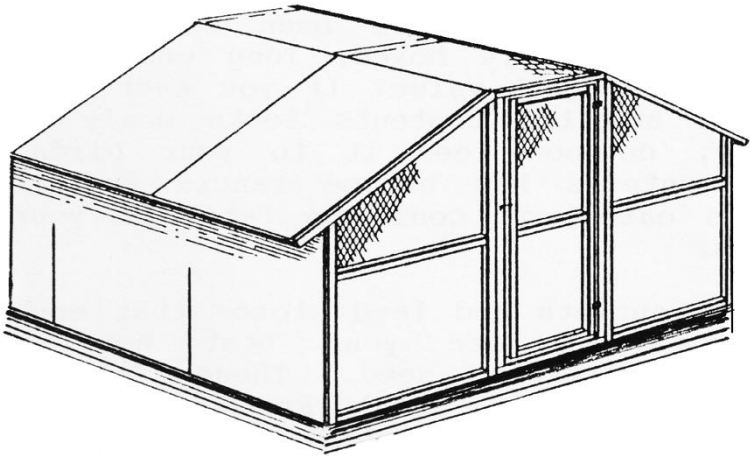

This aviary could from the end opposite of aviary be heated and lighted, be added onto the door shown.

## DIET FOR CANARIES

There are so many seed and seed related products on the market today it becomes confusing what is best for your canaries. Diet for your canaries will undoubtedly be the most controversial subject when speaking with other breeders. Some go for the lesser priced seeds and products.

I am not sure this is wise. You get what you pay for. However, if the diet you have your birds on is keeping your birds healthy, breeding well, and if you are having good results, by all means stay with it.

The opinion worldwide by experts and top breeders do agree is, that canaries are seed eaters. Some say that 90 to 95 percent of the diet of canaries should be seeds.

It is not my intention to promote or degrade any seed company or their product, but I will caution the buying of seed or products that has been boxed. How long ago was it boxed; long enough to lose the food value? If you ever open a box and the contents looks mealy or webby, do not feed it to your birds. The contents has become rancid and if it is eaten, it could be fatal to your birds.

Larger outlets and feed stores that move seed rapidly are your best bet in obtaining fresh seed. These outlets usually have bulk seed. Fresh seed will look clean and will have a shine. You can inspect before you buy.

Several canary mixes are available. Some are fortified with minerals and vitamins.

I use a seed mixture that is fortified with minerals and vitamins. I add to this mixture other seeds that are not in this mixture. I also add blue mineral grit. A diet for conditioning canaries and nestling food is another story. That will be covered later.

## GOING LIGHT

Going light is a term used when a canary is down and out health wise. Signs are, feathers fluffed, not active, sleeping in the day time, in general looks weak and sitting in the feed dish trying to eat. If you catch the bird and feel the breast bone and if it feels sharp, your bird has lost weight and has probably gone light. Usually this is caused by an incorrect diet. Too much soft food. What is considered soft food?

Consider anything that is not a seed, soft food. Most people kill with kindness. They will eat all the apple, lettuce or any fruit and greens put in their cage. Remember canaries are seed eaters and yes, they will eat anything; such as, apples, lettuce and greens etc. But if they stay full of this stuff, they will not eat their seeds. Soft foods are beneficial to your birds, but just in small amounts. Lettuce has no food value. Feed chard, broccoli, comfrey and any of the dark greens. Depending on how many birds you have in a cage, only feed just enough to where it is all gone in 10 or 15 minutes about twice a week. Some breeders do not feed greens at all. Do not kill your birds with kindness!

## BENEFICIAL SEEDS

CANARY: Principal item of canary Diet.

RAPE: Rich in magnesia, lime, potash.

HEMP: Nourishing, fattening, warming.

POPPY: Corrects loose bowels.

NIGER: Enriches plumage.

ANISE: Relieves gas, contains oil.

FLAX: Gloss to plumage during moult.

LINSEED: Strengthens respiratory tract.

SESAME: High in fats and oils.

SUNFLOWER: Rich in oil, feed crushed.

TEAZLE: Nitrogenous, natural tonic.

GROAT OATS: Fattening, use sparingly.

## PELLETS

In recent years pellets have come on the market for birds. For canaries they are called "crumbles." The sales pitch is, convenient, no mess to clean, cheaper, no waste, the only food your birds will ever need for good health. After offering crumbles to my canaries once, they refused to eat them. I have not bothered since. I have heard of canaries going light in an overnight change from a seed diet to a crumbles diet. There is no doubt that the ingredients are nutritious, they will not harm your birds. Canaries have survived on natural seeds for hundreds and hundreds of years and there is a saying, "if it is not broken, don't fix it." Another aspect on feeding crumbles is, when you sell a canary to someone you must tell them the bird is on crumbles. Does this mean that they will have to keep the canary on crumbles in a separate cage? change. Ask many questions before you change.

## BREEDING CANARIES

Beyond a doubt conditioning your canaries before you attempt to breed is the most important aspect in successful breeding.

What does conditioning canaries mean?

Why do we have to condition canaries for breeding? How do we condition canaries for breeding?

As bird fanciers sometime we tend to forget that we have our birds in captivity. As their keepers we give them the proper food they need, clean after them and keep them healthy. In return they show us their beautiful colors, sing for us, perform for us and keep us company. We must remind ourselves at times that we have them living in an unnatural environment when caged.

One of those times is when we want them to breed. In the wild or in their natural habitat, all of the food sources they need are available for them to seek out and take what they need to keep their systems balanced chemically. We all know what happens in the springtime of the year when the weather starts to get warm. New plant life begins to flourish, flowers begin to bloom bringing the bees to spread the pollen, insects become plentiful. All these are sources of food that birds do not have all through the long winter. They are free to move around to find the food they need and there is plenty for all. With the days growing longer in the springtime, they have more hours of feeding time. They will settle in an area where the food sources are abundant and begin to condition themselves for the breeding season.

How do we match this natural environment with our caged birds? IMPOSSIBLE!!!,but we have to try.

So far, three vital requirements mentioned to condition breeding. First the WARMTH of Spring. Heat is a factor in breeding. Second, THE EXTRA SOURCES OF FOOD. Third, THE LENGTH OF FEEDING TIME, I will throw in another requirement also important, THE SONG OF THE MALE, it stimulates courtship. Let us try to give our caged birds these requirements.

First, we need a room that is enclosed so we can control heat and lighting. We need two large flight cages, one for the hens, one for the males. You now have four requirements you need to condition birds for breeding: controlled heat - 60 to 68 degrees, controlled lighting - 14 to 16 hours a day, and the song of the male at will. The fourth requirement is controlled lighting. The extra food goes hand in hand with controlled lighting - the longer the lights stay on, the longer the birds get to eat the food provided.

There is some confusion about nesting food and condition food. They are the same. Feed store outlets will label it nesting food.

Nesting/conditioning food also differs from nestling food. Note there is an (l) in nestling food - the food the hen feeds to her baby chicks. Do not be confused when feeding or in buying these food. Many breeders make their own. Some formulas later.

Conditioning food is a subject that many people differ on. Some will affectionally argue that their formula is the best, some will keep it a secret. Read all the formulas you can find, try one; if it works for you, stay with it. There are various conditioning/nesting mixtures at bird supply outlets, but are they fresh? I have found a product that serves as both a conditioning food and a nestling food for the chicks. I will share it with you.

The food I use is called CE DE EGGFOOD.

The two-pound box comes from Holland. There are many feed store outlets that sell this product across America. It also advertised in bird magazines. Ask for the following liquid vitamins also.

FORMULA:

1 cup dry Ce De Eggfood.

1/ 4 cup distilled water.

10 drops of OCE' FITOL.

10 drops of OCE' VIT.

20 drops of OCE' CHOLINE.

drops to 1/ 4 cup distilled water.

Add 2 grated hard-boiled eggs, mix well.

For conditioning canaries, feed every other day for 3 weeks. For nestling food (feeding chicks), feed 3 times a day or when needed. Make fresh each day. Depending on how many birds you have will determine how much you will make each day.

Twice a week I add chopped apples, carrots and other vegetables. Add mix well.

## HOUSING CANARIES FOR BREEDING

Breeding canaries in an open outside aviary exposed to the natural weather is not recommended. In some regions of the country the nights get very cold and the days are moderate. These are not ideal conditions for breeding canaries. A room in your house, a garage or a bird room you construct would be better. We have been over controlled heating and lighting; adequate ventilation is also important. We will cover ventilation later.

### BREEDING CAGES

Cages for breeding canaries can vary in size. They should not be any smaller 12 inches high, 12 inches deep and at least 18 to 20 inches in length. Baby chicks often fall from the nest reaching for food. Tall cages with the nest high in the cage, contribute to severe injuries to a chick if it should fall.

Only the essentials are needed in a breeding cage: food, water, two perches and a nest.

Cages can be the wire type or made of wood with a wire front that can be taken off for easy cleaning. To save space a group of breeding cages can be easily constructed with a book case. These book cases can be obtained at a hardware store. Some come 48 inches long and about 12 inches high and 11 inches deep. They are made of unpainted particle board with 4 shelves. Divide the 4-foot shelves with a partition and you have 8 breeding cages you could stand against a wall.

A tray made of wood or metal that slides in and out is convenient for cleaning. Make the front of the tray high enough to cover the wire front by an inch or so. Use a nontoxic paint for the inside of the cage.

### SEPARATE HENS FROM MALES

Put only the hens in the breeding cages for conditioning. The hens will be fed the conditioning food each day. The males will become too hyperactive if given conditioning food each day. Give the males a smaller portion of the conditioning food twice a week. The males will be nearby singing to the hens. Always keep the regular seeds in the breeding cage with the conditioning food.

### COLONY BREEDING

Colony breeding means several hens and males in a large cage or aviary free to do as they wish. You have no control in this situation. No control with color or matching birds for certain traits for a better conformation. When it's feeding time for the chicks, who eats the food? Do the chicks get any at all? Also, the hens refuse to come off the nest because of fear that all the other birds may harm her chicks. This is why one hen per breeding cage is recommended.

### NESTS

I have heard of breeders using cut off milk cartons, boxes and almost anything that a hen can sit in as nests.

I never hear of the success rate of egg hatching with these crude type nests. Fresh air and humidity must be able to flow through the nest and nesting material to the eggs for incubation. Humidity is very important. Of course, a controlled humidifier would be ideal in the breeding room, but there are other ways. A vaporizer with water only manually controlled. Shallow pans of water sitting around the breeding room. In some areas humidity is not a problem. There are several nests on the market made of wire, plastic and wicker. I use the small wicker nests. I use the wicker nests because they are made of natural material. Nests can be too big for a canary. When the hen finishes her nest, her body should fit perfectly within the nest. Robert Stroud (The birdman of Alcatraz), claims that a canary will use on the average, 276 pieces of nesting material to build her nest. Mr. Stroud had plenty of time on his hands to count them, he with a clean nest after each clutch. should know. Replace nests

### NESTING MATERIAL

Never use lint from the clothes dryer for nesting material. Detergents still remain in the lint that will harm the eggs and the hen. Never use thread or any small material that can wrap around a leg or toe. Unnoticed it could sever a leg or toe. Goat hair, dry grass, twigs etc. can be used. The English use a nesting material that we Americans are not accustomed to. It is, soft grass bents, moss and teased out tow or short lengths of sisal string. Burlap bag material washed clean to get

rid of the odor, cut into 3-inch squares, (raveled out), makes excellent nesting material. It is soft and the color is not flashy. Toilet paper torn in small pieces for the bird to line her nest with works well. Fresh air and humidity can flow through these materials.

### BUILDING THE NEST

After the hen has been in the breeding cage with the conditioning food for about 15 days put a nest in the breeding cage. Make sure the nest is secure and will not tilt,

Put a small amount of nesting material in the breeding cage. If the hen is near being in breeding condition, she will start building the nest. If the hen carries the nesting material as far back in her beak as she can get it, she is coming into breeding condition. Some hens will build a nest in an hour, others take longer.

### SIGNS OF COPULATION

When a hen sits really low on a perch head way back and fluttering her wings, she is ready for copulation. Put the male in the breeding cage at this time. If the hen is ready, you may stand back and watch the breeding take place, It is very quick. If everything has gone well the hen should lay the first egg in about 3 days. Many breeders, including myself, take the male out at this time, perhaps to use with another hen. The male sometimes becomes a nuisance to the hen. The hen is capable of incubating the eggs and rearing the chicks without the presence of the male.

Many will disagree with me using this method, but I have had very good success using this method.

After the first egg is laid remove the egg from the nest and replace it with a dummy egg. Have your breeding cages numbered. At a hardware store you can obtain a nut and bolt organizer has pull out plastic trays that dividers making 3 spaces per tray,

Put something soft, I use sand, to place the egg on. Number these trays to correspond with the number on the breeding cage. Remove each egg as it is laid and place it in the plastic tray. As you put the egg in the tray turn the eggs that are already in the tray. Hens lay their eggs between the hours of 6 am and 8 am. Only one dummy egg in the nest is necessary. On the average a canary will lay 4 eggs. After the fourth egg is laid remove the dummy egg and put the four eggs from the tray in the nest.

Count on a calendar 14 days and put this information on the breeding cage in some manner. Using this method chicks will hatch on the same day; they will be the same size to compete for their food.

During the 14-day incubation period feed only seeds and water. The conditioning diet stops. Any soft food will only cause loose bowels. A sitting hen will get very little exercise. They will eat very lightly.

On the 13th day put some nestling food in the breeding cage. On the 14th day look for signs of the eggs being hatched out.

Egg shells on the bottom of the cage is usually the first sign of chicks being hatched, but not always. Sometimes the hen eats the shells.

Some eggs may not be fertile. They will be clear and will not hatch. Replace these eggs with dummy eggs. These dummy eggs will prevent the hen from sitting too tight on her chicks. If the hen sits too tight on her chicks, it may cause the chick to have spraddled legs, it will not have a chance to survive in this condition. You may have to put the chick down.

### YOKERS

A chick that does not have the right stuff to survive for life is called a Yoker.\* It is nothing that you did wrong, do not feel bad, A Yoker will die the first or second day. Chicks eat very little the first 24 hours, They are tiny and fragile, do not handle.

Chicks as they get older will reach for their food. They are awkward at this time and may fall out of the nest. Check the bottom of the cage for any chicks that may have fallen out before you turn the lights out for the night. A night light should always be on. Never leave a bird room in total darkness. A chick that has fallen out of the nest will get very cold. Hold the chick in your hand for about ten minutes to warm it up gradually and then return the chick to the nest. You just may save a chick by checking before you turn the lights out.

\* Spelling uncertain due to derivation from old English term.

## BANDING THE CHICKS

You must band your chicks when they are about 7 days old. If you wait longer than 7 days, you might not be able to get the band over the big part of the foot, where the toes connect.

Bands are for identification. The band will have a number, the year the chick hatched and the breeders initials. The color will change each year. If you order the bands through your club, the initials will be different from your own.

Canaries without bands requires a lot of convincing by the seller to the buyer about the age of the bird. There is no doubt when the bird is banded.

The chick at seven days old is small, but active. Covering the head and body and leaving the leg and foot exposed will quiet the chick down.

Hold the three front toes together, start the band over the three toes, working the band to the bigger part of the foot where the toes connect. After you get the band over this joint in the foot, continue to slide the band over the leg past the back claw. Pull the back claw forward and the banding is complete.

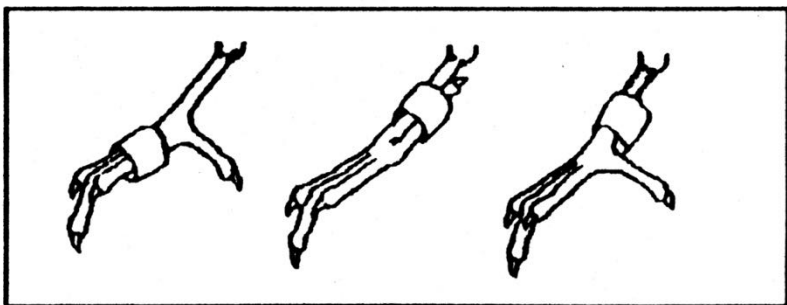

The band is foreign matter to the hen and she may try to get the band off the chick's leg. She may pull the chick out of the nest doing so. Watch out for this reaction and replace any fallen chick back to the nest. This band will stay on the bird's leg for life. At a glance you can tell how old the bird is by the color of the band. Coded retraceable bands are also available. See advertising in bird magazines.

### HAND FEEDING

I have heard more than once, that if you hand feed canaries, you will get out of the breeding business. I have never had to hand feed to save a chick's life. I give credit to the very best food I feed year-round. When breeding season comes, I let nature take its course.

With hand feeding we have a tendency to over feed or under feed. Only the parent knows the proper amount and the correct time in between feedings. I know breeders that hand feed with a great deal of success. Baby chicks need to build an immune system to fight bacteria. Chicks get beneficial bacteria from a salvia coming from the parents while feeding. Formulas for hand feeding contain this beneficial bacteria and are available on the market. The beneficia bacteria in these formulas acidifies the gut of baby chicks so that other friendly bacteria can colonize. One such formula is called PRIME by Hartz. Sorry address unknown. I refer you to bird magazine advertising or a bird veterinarian for this information.

It has been recorded in countries other than America some breeders have crop washed birds for the natural saliva to mix with the food used for hand feeding chicks. This method is not recommended because of disease transmission.

### KEEPING THE NEST CLEAN

The hen will keep the nest clean of defecation until the chicks are old enough to defecate over the side of the nest. Chicks at the age of 8 to 10 days will defecate over the side of the nest. Not appetizing, but the hen consumes the chick's defecation for the first several days and it is returned to the chick along with the food source.

### CHICKS LEAVING NEST

Chicks start sitting on the side of the nest about 15 days of age. They try out their wings for the first time. A natural instinct tells the chick, you can fly. Some chicks once they leave the nest never return. Others do go back in the nest. They are not sure it's time.

Unfortunately, it is at this time the hen may pull feathers from the chick. All hens will not pull feathers. It may be necessary to put the hen and her chicks in another cage that has been prepared with a partition separating the chicks from the hen. A wire partition with holes 1 inch square about 2 inches from the bottom is one solution. The hen can feed her chicks through the hole, but will not be able to pull feathers from the chicks.

I have heard that spraying the chick lightly with perfume will prevent feather plucking, but I would not recommend perfume spraying.

## WEANING THE CHICKS

Like a human depend on the parent as can for food. There comes the chick must be weaned. child a baby chick will long as they a time when Weaning chicks may become a critical time for both chicks and the breeder. Chicks will sit on a perch and beg for food. Take the perches out of the cage during the day. This will place the chick on the bottom of the cage with the food.

Sprinkle rape or niger seeds on the food. The black color of rape and niger will get their attention and the chick will start pecking at these seeds. If they get a taste of the food, they will start eating.

By putting regular canary mix in a blender on slow speed, it will knock the husks off making it easier for the chick to eat the seed. Place this seed in a shallow tray on the bottom of the cage next to their food. You might be surprised how quick the chick will learn to eat on their own.

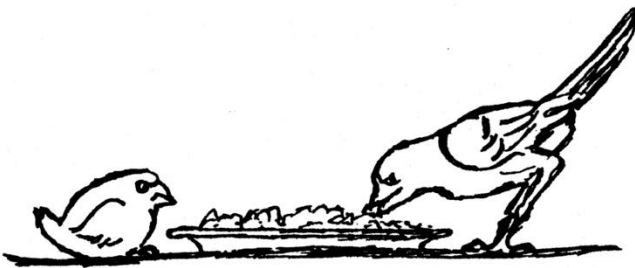

## FORMATION OF THE AVIAN EGG

This section should convince you that a hen must be in tip top condition to perform the act of forming an egg in the hen's reproduction system.

The egg is nature's way of reproducing the species. You cannot call the formation of an egg a miracle because it has occurred for millions of years on this earth, but I still find it amazing.

The ovary is a cluster of tiny eggs themselves.

Some are bigger than others. The ovary produces ovum and the yoke. When the ovum is fully mature and is ready to ovulate from the ovaries, it ruptures or breaks loose from the ovaries. The free ovum and yoke is surrounded by a very thin membrane. This ovum passes into the first area of the reproductive system called the INFUNDIBULUM.

If the hen has mated with a male, is where the male sperm hen has the ability to hold part of the male's sperm here for a second clutch, however, this does not always occur. The yoke or ovum will pick up the male's sperm in the white spot that is visible in a chicken egg and this white spot will become fertilized. The white spot is now called the BLASTODERM. The ovum will stay in this area for  $\frac{1}{4}$  hour, 15 minutes, that's all.

The ovum moves to the next area called the MAGNUM.

## SECTION TWO

### CONTENTS

FORMATION OF THE AVIAN EGG.....	22
EGG BINDING .....	26
THE BLUE EGG .....	26
HANDLING THE EGGS .....	27
CANDLING THE EGGS .....	28
THE MONOGAMOUS HEN .....	29
UNFLIGHTED BIRDS .....	31
SLIPPED CLAW .....	31
MOULTING .....	32
EXTERNAL PARASITES .....	35
RED MITES .....	36
SCALY LEG MITE .....	37
AIR SAC MITES .....	38
BUMBLEFOOT .....	40
TASSLE-FOOT .....	41
FEATHER LUMPS .....	42
SPOTTING SICK BIRDS .....	43
WORMS .....	44
THE BORDER CANARY .....	46
THE CRESTED CANARY .....	48
THE BELGIAN CANARY .....	50
THE SCOTCH FANCY CANARY .....	52
THE CORONA GLOSTER CANARY ...	54
THE YORKSHIRE CANARY .....	56

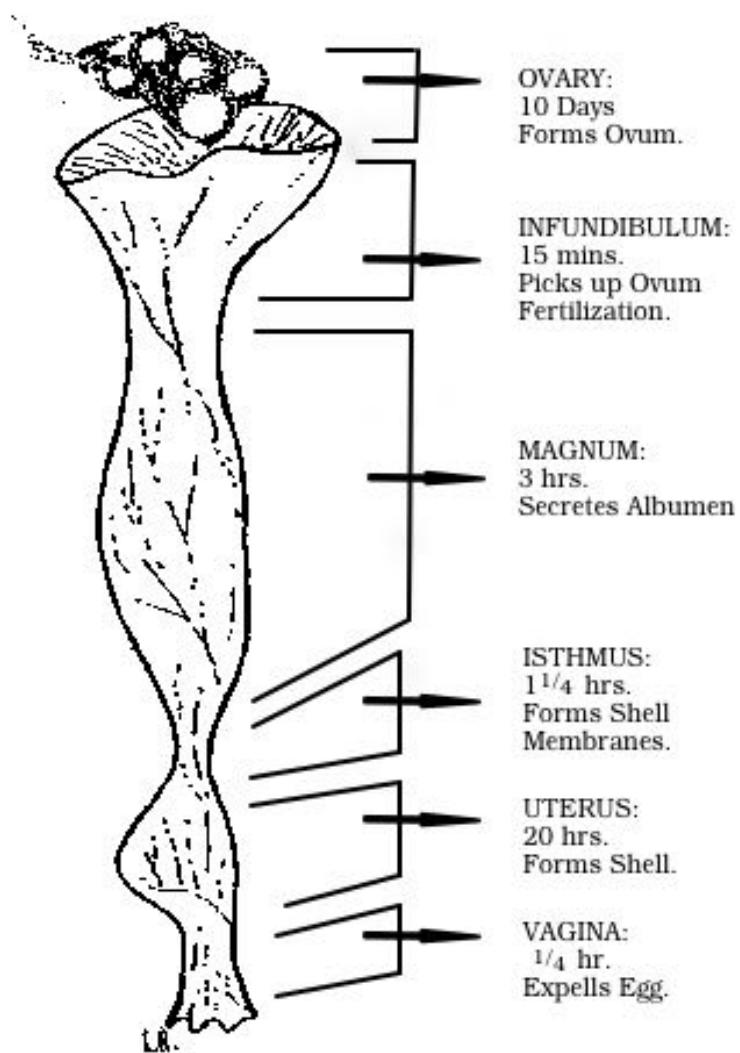

Adult female reproductive system

While the ovum is in the magnum area the albumen is formed. The albumen acts as a cushion that anchors and stabilizes the ovum. The magnum area does not have the ability to discriminate between the ovum and foreign bodies. The magnum area will deposit albumen around objects such as a cork or even a paper wad if surgically introduced. The ovum will stay in the magnum area 3 hours.

From the magnum area the ovum will pass to the ISTHMUS area. The ovum will stay in the isthmus area for 1 1/4 hours to form the shell membranes. This is the membrane the chick has to peck to get to the shell.

From the isthmus area the ovum passes to the UTERUS area. Here the shell is formed around the ovum. The shell consists entirely of calcium carbonate, but traces of sodium, potassium and magnesium salts are also present. The forming of the shell takes 20 hours.

A reminder that back up in the reproductive system, at some point, another egg is being formed at this time. One after another, sometimes up to as many as six, but the average is four to one clutch.

After the egg has its shell, it passes to the VAGINA and into the cloaca. Up until now the small end of the egg has been pointing upward, now the hen turns the egg 180 degrees so the pointed end of the egg is pointed downward.

If the egg does not turn so the pointed end is down, the hen may become egg bound. The turning of the egg takes about 15 minutes.

At this point the egg has been in the reproduction system for 24 hours. The egg is now ready to be laid. The egg passes out of the vent, finally at the end of its journey through the reproduction system. If everything has gone right, the egg will be complete and will be fertile.

The hen will complete laying her clutch of eggs, one every 24 hours. The hen's job is not complete yet. She must sit on the eggs for 14 days for the incubation period. Once again if everything has gone right, after 14 days of incubation, the chicks will hatch.

The hen's job is still not complete. After the chicks hatch, she must feed the chicks until the chicks are big enough to feed themselves, around 21 days of age.

The hen will have a natural desire to start all over with another clutch of eggs to produce some more chicks.

You should realize by now what a strain it must be for a hen to accomplish this amazing achievement. As a canary breeder you should not let the hen work more than two clutches in a breeding season and be willing to condition your hens before you attempt to breed.

You do not have to re-condition hens for the second clutch. The egg food the hen feeds the chicks keeps her in breeding condition.

## EGG BINDING

When a hen cannot pass the egg out through her vent, it is called egg binding or egg bound. The following are reasons that cause egg binding.

Calcium deficiency, sudden fall in the temperature, such as a draft, causing the hen to have a chill, lowering her body temperature. Hen unable to turn the egg pointing the small end of the egg downward. An overweight hen causing internal fat in the reproduction system may cause egg binding. The lack of Calcium in the diet at laying time is most important.

Calcium functions include its need in blood coagulation, muscle contraction, myocardial function and normal neuromuscular irritation.

Prepare a place where the temperature can be raised to 85 degrees, preferably a hospital cage. Handle the hen carefully, applying a vegetable or mineral oil around the vent area. The heat and the oil will help pass the egg. If the egg breaks inside the hen, it will be fatal. Do not try to force the egg out by hand. Leave the hen alone under these conditions for 2 or 3 hours and hope for the best. Egg binding does not happen very often. What has been described here is about all you can do to help the hen pass the egg.

## THE BLUE EGG

The blue egg is the last egg that is laid in a clutch.

Upon close observation the last egg laid in a clutch will appear to be a darker shade of blue

than the other eggs. The pale blue egg will be more obvious in some clutches than in others. I have taken notice that when a 5th or 6th egg is laid, the blue egg sometimes is not visible all. To my knowledge there is no explanation for the egg to be pale blue in a clutch of canary eggs.

### HANDLING THE EGGS

The only time you should be handling an egg is when you are transferring an egg from the nest to the storage tray where the eggs are being kept waiting for the 4th egg to be laid.

Each egg has a thin natural protective coating that must not be disturbed, This coating wards away germs and other elements that may harm the yoke mass if they penetrate the shell. There is enough natural oil on your fingers to remove this coating. Never wash an egg to remove defecation, etc. Sometimes the paper the hen used to line her nest will stick to the shell. You may pull some of the paper from the shell but the portion of paper that will not come off with a gentle pull, leave that portion on the shell.

Some breeders use a small plastic spoon to remove eggs from the nest. I have punctured holes in the shell with my finger nails. Once the shell has been penetrated, breeders usually throw that egg away.

However, I have heard of repairs being made by using a material called OPSITE. Opsite is a clear, sterile, scotch tape looking material, used in hospitals, holding intravenous needles in place.

## CANDLING THE EGGS

After eggs have been incubated 8 or 9 days, testing can be done to see if the eggs are fertile. It is not necessary to remove the egg from the nest to test the egg to see if the egg is fertile.

Candling eggs can be accomplished with a small pen light. Pen lights with a flexible hose like extension with a light at the end can be found in a hardware store or ordered from bird magazines.

Placing the light alongside an egg in the nest, you can determine if the egg is fertile by the light shining through the egg. A fertile egg no light can An egg that is not fertile will be clear, you can see the light through the egg. will be dark, be seen through the egg.

If all of the eggs are clear, take the hen off of the eggs and dispose of them. There is no gain by letting the hen sit on eggs that will not hatch.

Always take the clear eggs out of the nest. A hen will still sit tight on the chicks that have hatched if the clear eggs are in the nest. She will not come off the nest as she should to get food for her chicks, still trying to incubate the clear eggs.

Some breeders put a dummy egg back in the nest when the chicks are 3 or 4 days old for the chicks to lean on. If a hen sits too tight on her chicks, it may cause the chicks to have spraddled legs during the growth process. The weight of the hen keeps the small chicks from moving around and getting up on their feet.

The dummy egg will provide space for the chick between the bottom of the nest and the hen.

## THE MONOGAMOUS HEN

Birds that live in the wild are free to choose their mates for breeding. Staying within their own species, the hen will select the male she wishes to breed with, and sometimes this relationship will last forever, never allowing another male to come near her. These hens are called monogamous hens.

Even though the canary has been in captivity for hundreds of years, this natural trait still lingers in the genes of some of our canaries.

As breeders we are always trying to improve the quality of the off spring, so we select the hen and the male to produce the best chicks. Sometimes our selections are not the same wishes as our birds. Some hens still have that natural trait to choose her own mate. The monogamous hen will become a problem in a breeding cage.

A persistent male may win the battle in a small breeding cage, but as long as the hated male is present, the hen will be defensive and fight to the finish.

If a mating such as this produces a clutch of chicks, do not make the mistake of putting the male back in the cage to help feed the baby chicks, With baby chicks at her side, the hen will be twice as defensive. She may not only injure the male, but also kill the baby chicks.

Young hens going to nest for the first time may become monogamous hens. After mating them to one male for the first mating of the season, they may refuse to mate with another male for the second mating. Closed leg bands becomes very important for your identification of such a hen.

A breeding cage that you put a monogamous hen in will become her property. She will defend every inch of the cage. No other bird is allowed without her approval. If you have a monogamous hen and want to try to breed her with a male of your choice, try the following. Prepare a breeding cage with one perch, no nest. Put the male you would like for the hen to mate with in this cage. Let the male settle down for a while. Take the hen out of her cage she is accustomed to and put her with the male, away from her nest and her environment. You have taken the hen the hen away from her nest and her environment.

Sometimes this works and a mating will take place. Stay close by and keep an eye on them in case things do not go well. If a mating takes place remove the hen and return her to her cage with her nest. Good luck!!!

Now a question may arise. Will the monogamous hen pass this trait on to the baby chicks in her clutch? Sorry, I have no knowledge of this to share with you. You also may ask, why attempt a breeding with a monogamous hen in the first place? When breeding Type canaries, there may be a trait in one bird that is excellent that you would like to preserve in your strain.

## UNFLIGHTED BIRDS

Unflighted birds are young birds that are not old enough to go into an adult moult. During the adult moult the young birds gain their flight feathers and then they are referred to as flighted birds. The age of an unflighted bird will range from 3 to 10 weeks, depending on when the bird was hatched. A bird hatched in May will not have as long to wait for the environmental temperature change for its moult as a bird hatched in February or March. If you observe the young birds closely in this time frame, you might discover a few young males trying to sing. Use a plastic split band to mark these young males and you may prove yourself right later in the year. If no young males are found in this time frame, you will have to wait until the moult is over. Most canaries do not sing during the moulting period.

## SLIPPED CLAW

This is a defective condition of the foot in which the hind toe suffers some form of dislocation, either by slipping forward under the three front toes or backwards against the shank of the leg. In either case this prevents the bird from gripping its perch properly. Slipped claws often happen during the weaning period or shortly afterwards. It is during this weaning period that a number of different size perches should be used. Sometimes the very end of a tree limb where the branches are small and different sizes could be used.

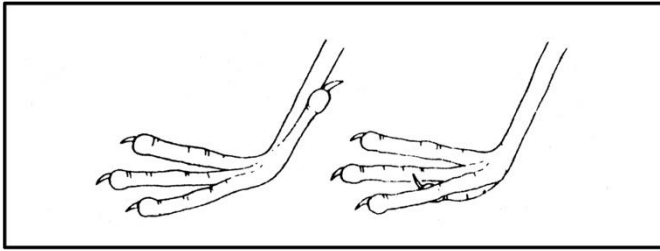

A forward slipped claw is relatively easily dealt with by gently tying back the displaced joint against the shank of the leg for a period of about a week or ten days. This may be done with a split plastic leg band.

The backward dislocation is rather more difficult to deal with and the best treatment is probably to substitute the standard perches with natural springy twigs of about the thickness of a pencil until the young bird is seen to be gripping properly once again.

## MOULTING

When you start finding feathers everywhere, but your birds are acting healthy, not fighting or pulling feathers, it is probably moulting time.

Moulting is a perfectly natural avian event.

Eventually the time comes when a bird must replace the feathers that are worn out or become frayed, broken or loose.

In larger birds the moult is so gradual that you hardly notice the place where the feathers are missing. These birds moult longer than canaries.

With canaries, once the environmental temperature is correct for the moult, the moult of a canary is usually over in about 6 weeks.

In some areas the temperature will go up and down during the summer season. This will cause a canary to go into a soft moult more than once.



The new feather grows from the skin in a sheath called a pinfeather. When the pinfeather is nearly mature, it splits open to reveal the fully formed feather. The bird removes the pieces of the sheath during its preening, dropping what looks like dandruff onto the floor of the cage.

Most of the feather structure is protein, with traces of fats and minerals to provide stiffness, strength and color. This means that a bird's diet must have an adequate amount of complete protein to supply the needs of its growing feathers. If the protein content of the diet is too low, the new feathers may be poorly formed, or the moult may be incomplete and only a portion of the feathers will be replaced. In the worst case, a protein deficiency during the moult will cause a bird to die. This is especially true of young birds going through their first moult.

A good source of protein for caged birds would be mashed, hard boiled eggs. You can teach canaries to eat insects like meal worms etc.

These are excellent sources of protein during the moult. Monkey chow and high protein dog food are also good sources of protein.

Canaries will eat anything that has been added to cornbread, but remember cornbread is a soft food; do not over feed cornbread. It may cause your canaries to go light.

All small birds are sexually mature when they complete their first moult. Only the larger birds have to go through several moults before they reach sexual maturity.

Generally, a good diet will bring a bird through its moult in excellent health and color and it should remain in beautiful feather until its next moult. Vacuum cleaners are the best way to eliminate feathers. Feathers do not sweep up well.

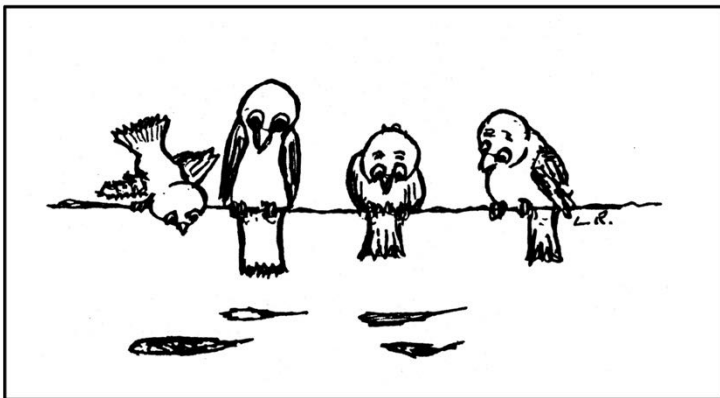

## EXTERNAL PARASITES

### FEATHER LICE:

As the name suggests, feather lice live on the bird. Feather lice are not blood suckers, but live by sucking the oil from the feathers of the bird. Feather lice attach their eggs, called NITS, to the shaft of the large feathers. When the larvae hatch, they at once begin to eat their way across the web of the feather, always at right angles to the shaft. Feather lice can spend their entire life cycle on one bird. They are a constant irritation to the bird. A severe infection will produce extreme fatigue causing inability to sleep and eventually erode the bird's natural resistance to infection.



## TREATMENT FOR FEATHER LICE:

A Veterinarian's advice and treatment is always recommended.

Treatment of Feather Lice is possible by means of an insecticide spray or powder. One such insecticide is called Cage and Aviary Spray by Nutro. This insecticide can be used in a fogger.

I have had good results over the years controlling external parasites with a preventive program. Using equal parts of Listerine and Witch Hazel in the bird's bath water twice a week. Storing this mixture in a plastic squeeze bottle, one squeeze in the bath water is sufficient.

## RED MITES

Unlike feather lice, red mites are blood-suckers. They can live off the host bird and infest in enormous numbers in all the cracks and crevices in the cage or aviary. The red mite comes out at night to feed on the roosting birds. As they are so numerous, their blood-sucking can give rise to a severe anemia, which is often fatal to young chicks in the nest.

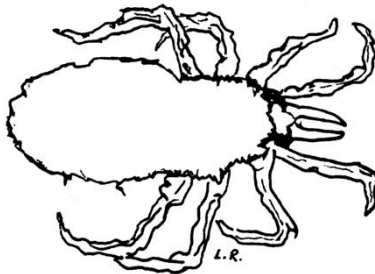

## TREATMENT FOR RED MITES:

A Veterinarian's advice and treatment is always recommended.

The Cage and Aviary Spray by Nutro mentioned before can also be used for treatment of the red mite. Since the red mite leaves the host, infesting the cages and aviaries, they also need treatment.

There are several insecticides on the market to clean cages and aviaries. Some advertise you do not have to remove the birds when used. I would recommend removing the birds with any insecticides.

I use plain liquid bleach sprayed on the cages and aviaries at full strength rinsed off and allowed to dry in the sun for a full day. Do not put bleach on the birds!!!

## SCALY LEG MITE

If your bird's feet always looks dirty and the scales are enlarged, they are probably infested with scaly leg mites.

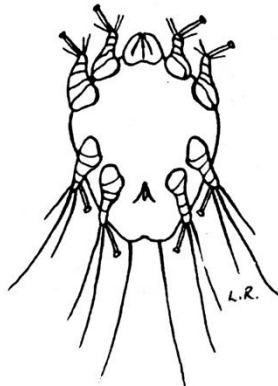

The scales will be loose and there will appear to be a white powder under them.

The white powder is the excreta from the thousands of the scaly leg mites eating their way under the scales on the bird's feet and breeding there. The scaly leg mite is usually introduced by new birds you obtain for new stock.

Look birds over very carefully before you buy.

### TREATMENT FOR SCALY LEG MITE:

A Veterinarian's advice and treatment is always recommended.

Anoint the feet of the birds with one percent carbolated Vaseline and paint your perches with creosol disinfectant, thoroughly cleaning them with soap and water.

Vetrx and other treatments for scaly leg mites can be ordered from bird magazines. Make sure you follow directions with these treatments.

There are many home remedy concoctions that I could mention, but I choose not to because of the harm you may do to your bird.

### AIR SAC MITES

Mention air sac mites around a serious bird breeder and you may see some trembling going on.

Because of the complex respiratory system of birds, air sac mites are very difficult to eliminate with medication. Sometimes the treatment will take up to 30 days or longer.

Infected birds show signs of respiratory distress by coughing, sneezing, gasping with a particular moist clicking sound.

At times air sac mite infections gets diagnosed by a breeder as just a common cold and is treated as such, Only a vet can confirm the disease.

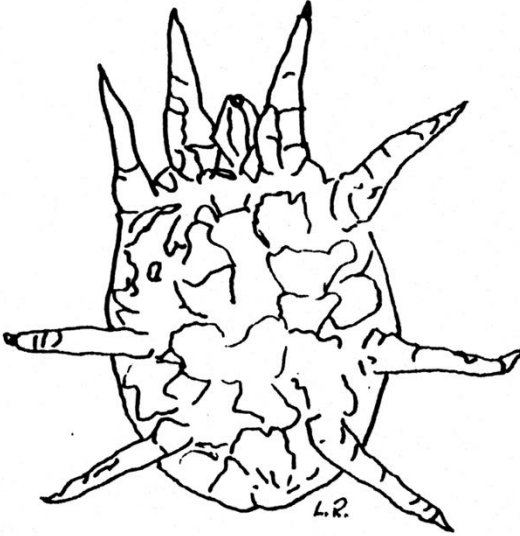

#### TREATMENT FOR AIR SAC MITES:

Only a Veterinarian can diagnosis this disease and give the correct medication.

## BUMBLEFOOT

Bumblefoot is an infection or abscess of the foot pad and/or the structures it protects. The Avian foot pad is a cushion of skin, fat and connective tissue covering the tendons, joints and blood vessels of the foot's sole.

Bumblefoot is caused by a combination of unclean environment and trauma. Perches that have an excessive buildup of excrement expose the bottom of the bird's foot to an abundance of bacteria, Wet perches serve as a growth media for bacteria.



Trauma can occur in many forms: sandpaper perch liners continuously abrading the bottom of the foot, allowing entry of bacteria; overgrown toenails puncturing the foot pad; the bird itself pecking at the foot.

### TREATMENT:

Depending on the degree of infection, local antibiotics, disinfectants can be effective. More advanced cases may require surgical intervention by a Vet. In very severe cases, euthanasia may be recommended for humane reasons.

## TASSEL-FOOT

Tassel-foot is common among Canaries. Tassel-foot is a parasitic form of scaly-leg, scaly-lesions or horny- like growths formed on the surfaces of the toes and feet. The foot may appear to be web-footed with this gray or white growth.



These growths make it difficult for the bird to perch and cause the bird to rest on one foot or sometime alternating feet while on the perch. In severe cases, the bird will not attempt to perch, staying on the bottom of the cage.

**TREATMENT:** Ivermectin.

A Veterinarian's advice and treatment is always recommended. A Vet. could administer in three ways. For Canaries, one-part Ivermectin to 100 parts of sterile water, is used for injection. For oral dosage, one drop of Ivermectin to 50 drops of sterile water is used. The third way is placing a drop of Ivermectin on the bare skin under the wing and rub it into the skin. Using either method, the feet of the bird should clear up of tassel-foot in seven to ten days.

## FEATHER LUMPS

Mention feather lumps or feather cysts to a Canary breeder and they will shudder at the thought.

Feather lumps are new feathers that will not or cannot grow normally through the bird's skin. As the small feathers grow it forms a lump under the skin; sizes vary, some small, some very large. The general appearance of a feather lump will be a lump filled with a yellow/white cheesy material under the surface of the skin. The new feathers keep curling around in the lump causing inflammatory irritation.

Feather lumps are most common in Norwich and crested breeds of Canaries, sometime as much as 5%. The wings and back are the most common place feather lumps are found on a bird. They can be found on young birds as well as older birds.

Opinions differ on why birds have feather lumps. The most popular opinion is that feather lumps are of genetic transmission by breeding buff to buff birds. A buff bird will be explained later. However, Gloster breeders have bred buff to buff for years, yet feather lumps have never appeared in Glosters.

Feather lumps may not show up on a bird until the second or third year or longer. Do not breed canaries that have feather lumps.

Diet and stress have been mentioned as the cause of feather lumps, but are very unlikely. A lot of speculation appears in print, most of it is accepted as nonsense, not fact.

Feather lumps will appear in the offspring of birds bred with feather lumps. Once a bird has feather lumps, it is probably incurable. The only way to eliminate the problem is to eliminate all birds with feather lumps.

TREATMENT: Surgical removal by a Veterinarian.

## SPOTTING SICK BIRDS

Only a Veterinarian may tell you what kind of sickness your bird has, but being the owner of the bird, you should be able to recognize the bird is in fact sick. Here are some warning signs.

If a bird has its head under the wing sleeping in the daylight hours, keep an eye on this bird for signs of sickness.

Birds having fluffed-up feathers, heavy breathing, wheezing, sneezing, Runny eyes and runny nose are birds to watch.

If a bird is listless, sitting on the bottom of the cage, not eating, no activity, droopy looking, the bird is sick. Watch for the above signs.

Being observant on a day-to-day basis can allow you to spot a sick bird preventing the sickness becoming well-advanced.

If fed the correct diet and living quarters kept clean, canaries can live a long healthy life. One such case of a canary living a long life was in San Diego, Ca. The canary lived to a ripe age of 24 years.

## WORMS

Wormlike parasites can damage or cause death to our birds if gone un-checked.

Three major groups of worms are:

NEMATODES: Roundworms and Gapeworms.

CESTODES: Tapeworms.

TREMATODES: Flukes.

Only a Veterinarian's microscopic examination of the stool will diagnose infestation and what type worm your bird may have.

Signs to watch for: your bird's feathers may look ruffled, poor color, thinness look, diarrhea, constipation and anemia may be present. Worms can infect the respiratory system. The unfortunate birds will open their mouths widely and extend their necks, gasping for air. They may also cough and shake their heads, as if trying to dislodge the obstruction. Most breeders worm their birds twice a year. One time is before breeding.

TREATMENT: Treatment consists of using drugs such as Piperazine, Levamisole or Mebendazole; however, these treatments have only been barely satisfactory. Recent experimental use of the drug Ivermectin has given Veterinarians incredibly good results. This drug holds promise of being an effective and safe cure for many parasitic infestations. A Veterinarian's advice and treatment is always recommended.

## RECOGNIZING THE DIFFERENT

### SPECIES OF CANARIES

Canaries are canaries, they are yellow and they sing.

If you believe the above statement, are only seeing the tip of the iceberg.

you

Unless you have the opportunity to attend one of the larger bird shows, you may not see all of the recognized species of canaries at one gathering.

One such bird show that would have all recognized species of canaries on exhibit would be The National Cage Bird Show. The

National is the largest bird show in America. The National is held in a different major city each year. Moving around to a different city gives more bird enthusiasts the opportunity to attend.

If you are a beginner, it is recommended that you join a local Canary Club. Being a member of a club, you will be informed where all bird shows are being held.

Take advantage of the knowledge you learn about canaries at bird club meetings and at the bird shows.

The first group of canaries recognized for the next 20 or so pages will be the TYPE CANARIES.

Think of type canaries as thoroughbred canaries. Like any thoroughbred animal, these birds should not be bred with any species other than their own. Type canaries have certain characteristics that other canaries do not have. These characteristics must be maintained in the Type canary when breeding.

## BRIEF HISTORY

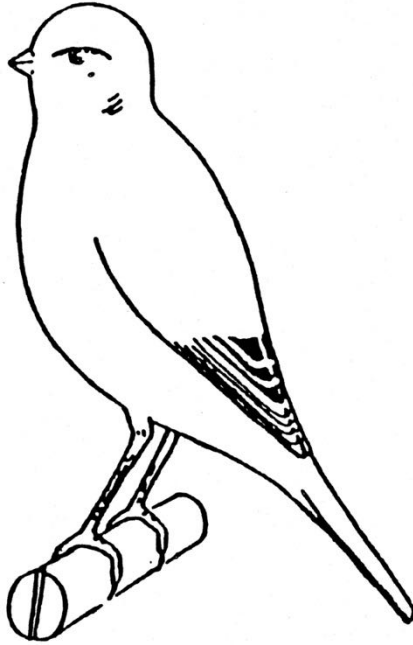

### THE BORDER CANARY

The exact origin of the Border Canary is open to debate. It is believed that selective breeding of the Common Canary developed the shape of the Border. This continued selective breeding since the late 1800's until the present time has produced the most popular Canary to breed and to show of all Canaries.

Not only has the Border maintained its position at the top of the popularity poll, it still is increasing in popularity,

Evidence of this is quite clear At leading Bird Shows there are almost as many Borders as all others varieties put together. The record stands at well over 2000 Borders for a single show.

To maintain good feather texture Border breeders have always kept an important rule, to always pair a Yellow feathered bird to one of Buff feathering. Due to this pairing the Border has remained free from major feather faults such as feather cysts and loose feathers. Borders are free breeders, excellent for the beginner and inexpensive compared to other Type Canaries.

---

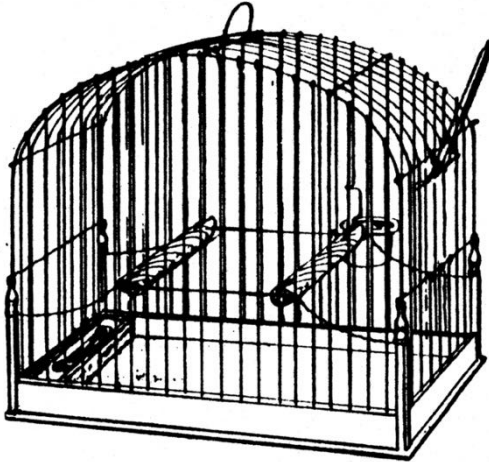

THE BORDER SHOW CAGE

## BRIEF HISTORY

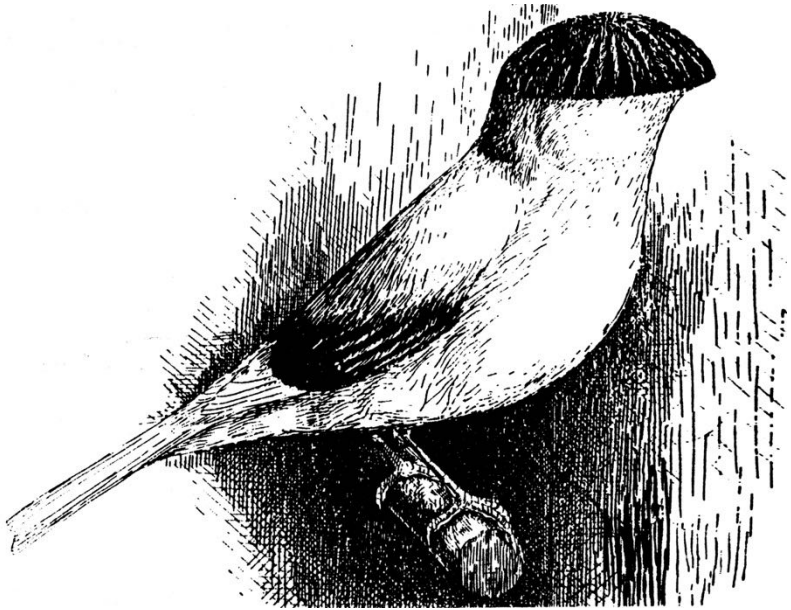

### THE CRESTED CANARY

The Crested Canary is a very ancient breed that was originally known as the TURN-CROWN or TURN-CREST. The characteristic head adornment that gave the bird its name appeared as a mutation sometime during the 18th century.

No standard was ever written for the Crested Canary because of disagreements between breeders and judges. Some believed it was cruel to breed such a bird that could not see properly, no visible beak or eye to make a face for the viewer, because of the heavy overhanging crest.

It is believed the Crested Canary was produced by cross breeding a Norwich and a Lancashire Cobby. The idea was to produce a very large, broad neck, coarse feathered bird with a crest to equal no other.

This bird is not to be confused with the modern-day Norwich or the Gloster Canary. It is neither. The true Crested Canary is in the hands of only a few enthusiasts today, hoping to preserve this old breed, until one day the breed can have a new lease on life and find its way to the show bench with a standard.

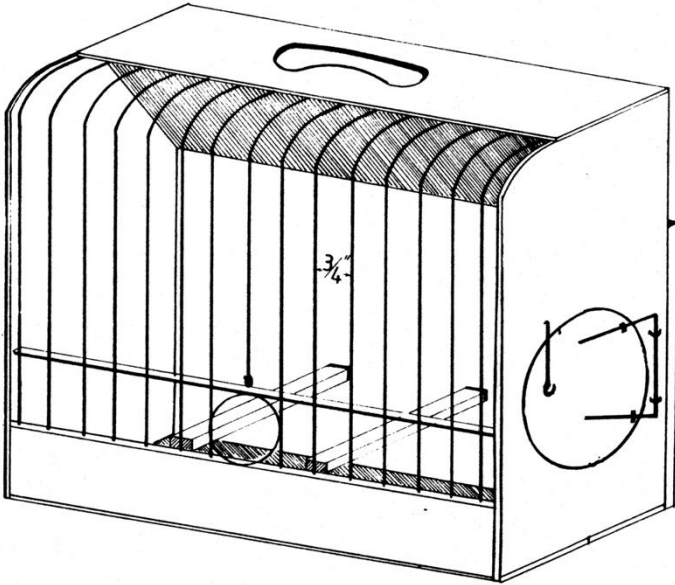

THE CRESTED CANARY SHOW CAGE

## BRIEF HISTORY

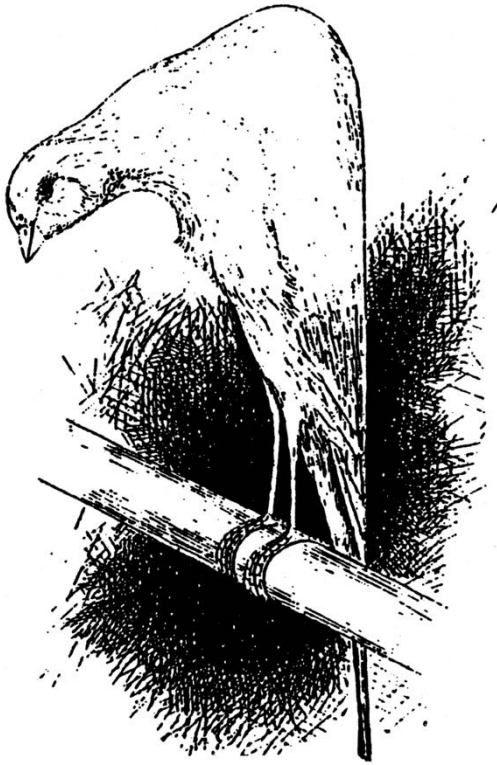

### THE BELGIAN CANARY

The ugly bird, horrid looking thing, nature's mistake, Belgian Humpback. These were some names the Belgian Canary had in its heyday. The heyday is long gone. The true blood of this remarkable bird was whipped out by World War 1 and World War 2, but how did this creature come into being, what was its origin?

G.J. Barnesby, an expert on Canaries, had this to say.

"it may be assumed that selection in pairing and breeding was the cause of producing birds of greater length than the much talked about originals of the Canary Islands, and that the offspring from such selections, developing somewhat of a curvature of the upper portion of spine, may have at length produced the birds known as Belgians.

There is little doubt that many rejects were destroyed in the breeding process of perfection of the Belgian Canary. As to further trying to unravel the puzzle, I must be excused." In most cases the Belgian Canary hens are considered to be unreliable mothers; most breeders foster out the young.

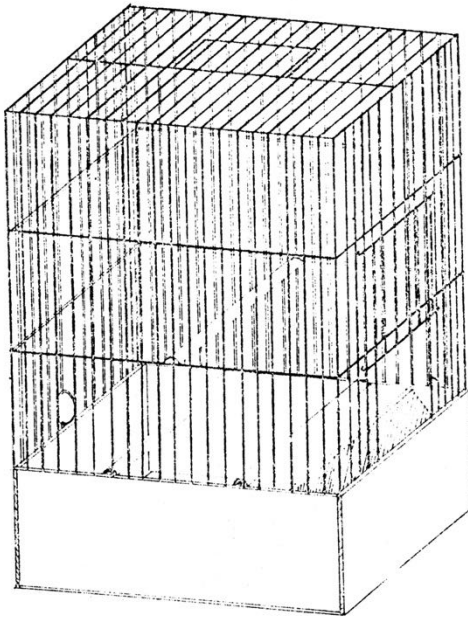

THE BELGIAN CANARY SHOW CAGE

## BRIEF HISTORY

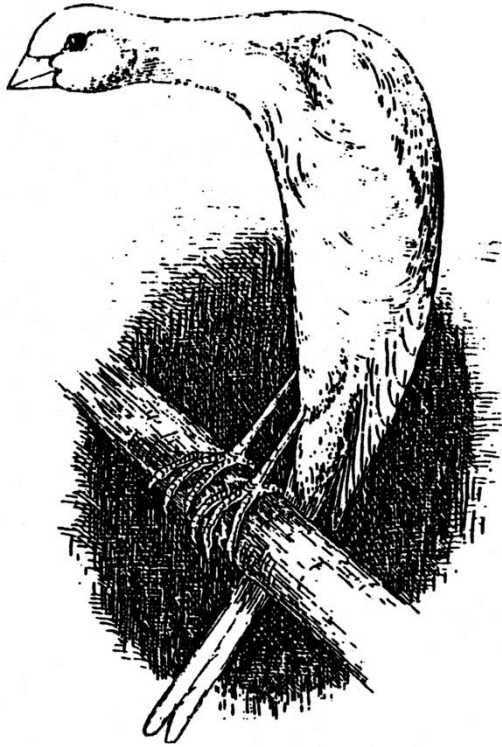

### THE SCOTCH FANCY CANARY

Comparing the bird above and the bird on page 50, you can readily figure out the origin of the Scotch Fancy Canary.

First came the Belgian Canary then the Scotch Fancy Canary. Don't try to tell a Scotchman that around Glasgow, Scotland. The Scotch lay claim they bred the Scotch Fancy without the presence of the Belgian Canary. They called the bird, "Glasgow Don."

There are many different characteristics in the two birds. Compare the straight up and down back and legs on the Belgian to the curved back and angled legs from the body of the Scotch Fancy. The Belgian has the humpback look, where the Scotch Fancy does not. The natural neck head position of the Belgian is as if the bird is looking down at the bottom of the cage. The Scotch's head and neck is straight, the eye even with the shoulders. The Belgian has a figure no. 7 look, the Scotch has an arc or curve look from the shoulders to the end of the tail. Both birds are known to be "birds of position". Both the Belgian and the Scotch Fancy get "the longer look" when on display

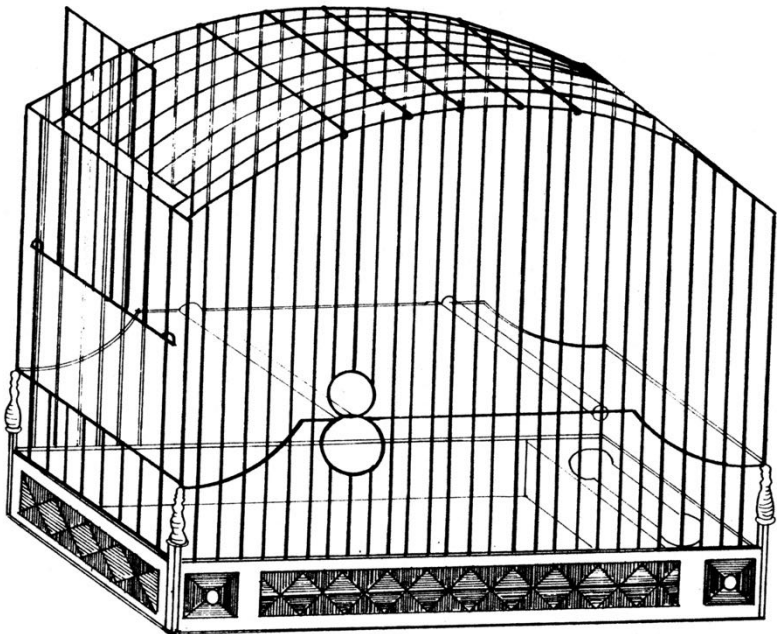

THE SCOTCH FANCY SHOW CAGE

## BRIEF HISTORY

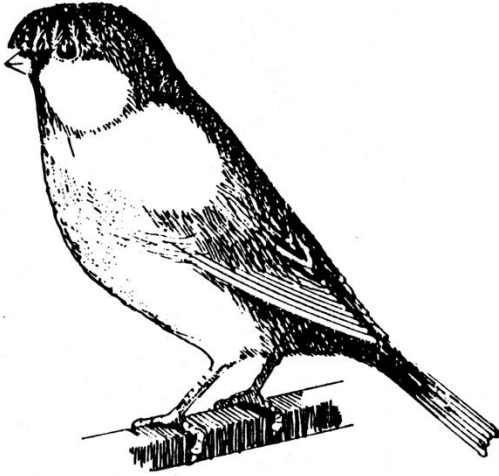

### THE CORONA GLOSTER CANARY

The origin of the Gloster Canary is quite clear. Compared to dates of origin of other Type Canaries, you could say it was accomplished in recent times.

In 1925 a Mrs. Rogerson of Cheltenham England selected two of her best offspring that she had been breeding between Rollers and very small Borders and entered them in the Crystal Palace National Bird Show.

With the persistence of Mr. A.W. Smith, a Crest breeder at that show who argued defiantly that these two exhibits did have a delightful quality all of their own, and after swaying his fellow officials to accept them as miniature Crests, these two birds were awarded a first and second prize.

## BRIEF HISTORY

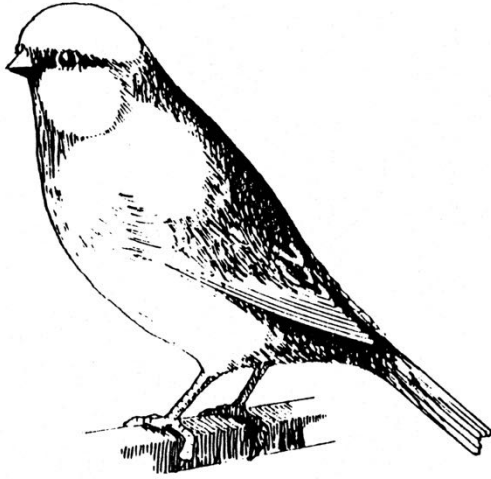

### THE CONSORT GLOSTER CANARY

The first hurdle had been cleared: a successful appearance under the guise of the miniature Crest, but the new breed did not have a name.

In appreciation of the work done by Mrs.

Rogerson, Mr. Smith suggested the breed be named after the county that Mrs. Rogerson lived in, that being Gloucestershire. The Gloster Canary had its name and began to steal into the hearts of all who surveyed it. Correct pairing for breeding is Consort to Corona, sex can be either.

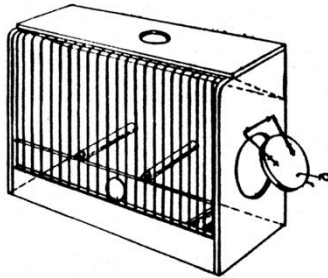

### THE GLOSTER SHOW CAGE

## BRIEF HISTORY

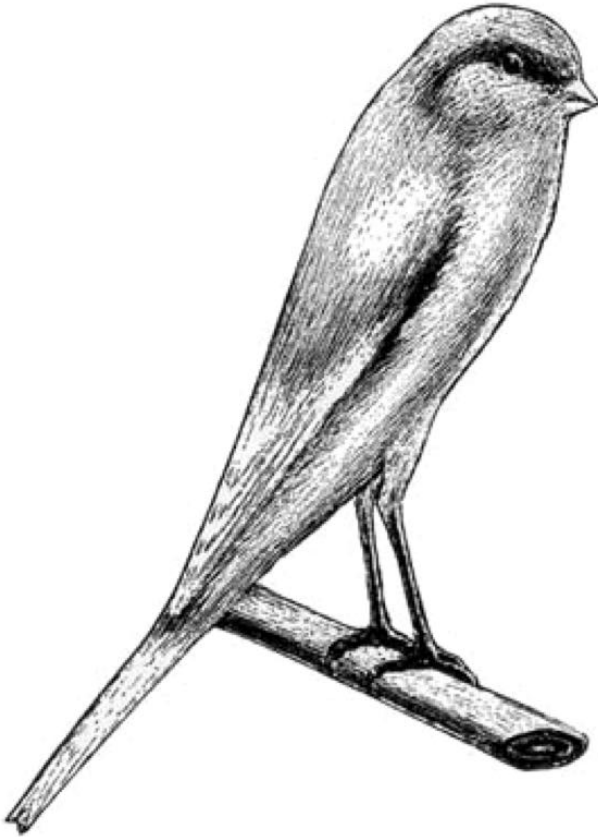

### THE YORKSHIRE CANARY

The origin of the Yorkshire Canary is in question, as good records were not kept. Most agree that the Lancashire Cobby was paired with either a Belgian Canary or a Border Canary. This resulted in a long and slender bird. Yorkshires made their appearance sometime in the 1880's. It is said at that time that a good Yorkshire Canary would be one that could pass through a wedding band.

The "Yorkie" as it is called, is a bird of position, and to win on a show bench the bird must have good constant training.

The up-right position the bird has when perched, gives you the impression that the bird is on guard. This led to the bird to be named the "Guardman."

The main faults with the Yorkies are the split chest and split tail. These two faults can be transferred to the young and once in the stud it is very difficult to eradicate. A small apple cut in half placed on top of a stubby carrot would give you the general conformation of the bird.



THE YORKSHIRE SHOW CAGE

## BRIEF HISTORY

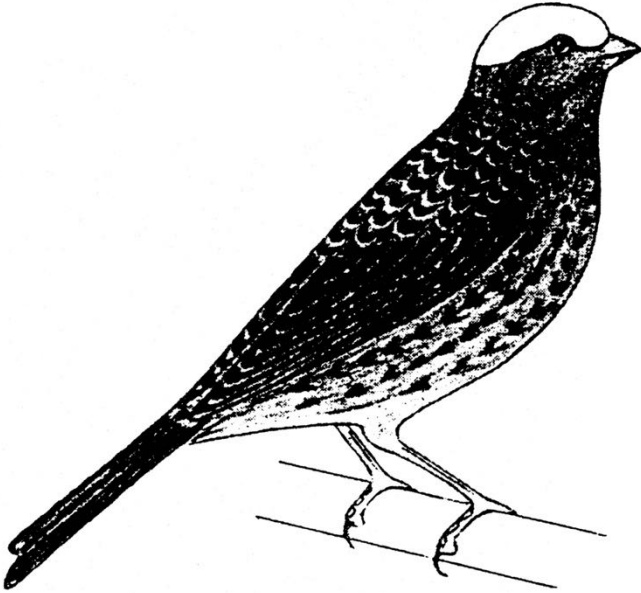

### THE LIZARD CANARY

Among the existing varieties of Canaries, the Lizard holds a unique position. All other breeds, at any rate in their present forms, are comparatively recent in development, several of them within memory, but the Lizard appears to have been bred without any changes in its characteristics for some centuries, dating so far back that its origin is not known.

The Lizard Canary possesses the basic pigments as does the green canary. It is a yellow ground bird. Variegation is not a characteristic of the Lizard.

## SECTION THREE

### CONTENTS

THE LIZARD CANARY .....	58
LANCASHIRE CANARIES .....	60
THE FIFE CANARY .....	62
THE NORWICH CANARY .....	64
THE FRILLED CANARY .....	66
COLOR-BRED CANARIES .....	68
LIPOCHROME CANARIES .....	69
MELANIN CANARIES .....	69
SOFT-FEATHER CANARIES .....	69
HARD-FEATHER CANARIES .....	69
COLOR-BRED CANARY STANDARD .....	71
VARIEGATED CANARY .....	72
LIPOCHROME COLOR-BRED CANARIES .	73
MELANIN COLOR-BRED CANARIES.....	74
COLOR INHERITANCE IN CANARIES.....	75
IN-BREEDING .....	77
LINE BREEDING CHART .....	78
COLOR FEEDING .....	79
CANTHAXANTHIN .....	80
COLOR ENHANCEMENT .....	81
FLAMEN OIL .....	82
SEXING CANARIES .....	83
BIRDROOM ENVIRONMENT .....	91
ARTIFICIAL LIGHTING .....	92
NATURAL SUNLIGHT .....	94
THE SALE OF A CANARY .....	95

on the crown of the head, (the cap) no light feathering whatsoever should be found on the body.

The main characteristic which makes the Lizard what it is, is its SPANGLING. The spangling is the series of black spots which run in parallel rows down the back and chest of the bird. These rows of spangling are formed by the over-lapping of the saddle feathers which are of a distinctive color. Twenty-five points out of 100 when being judged goes to the spangling.

It has been said that "whereas a noncapped Lizard bird, provided it has good spangling, is still a Lizard, yet a perfectly capped bird without spangling, is no Lizard at all."

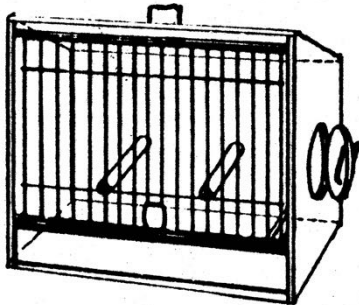
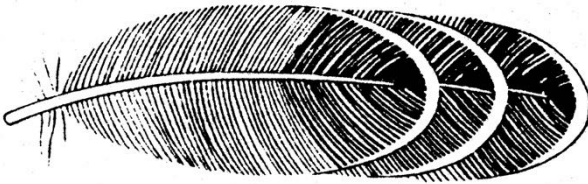

THE LIZARD SHOW CAGE

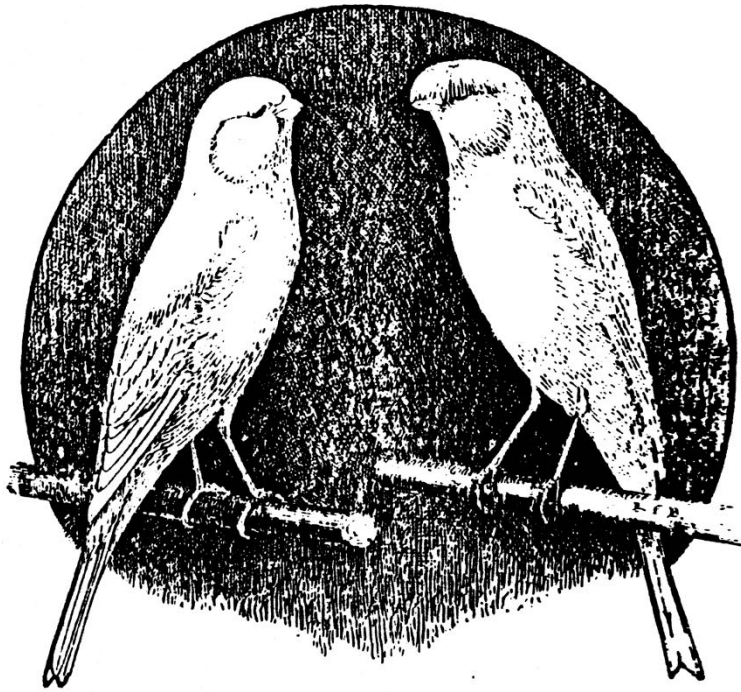

### LANCASHIRE COPPY AND PLAINHEAD CANARIES

The origin and early history of this Canary was never documented. It is believed that this bird was produced from offspring of the Old Dutch Canary and a Dutch Frill, but bred comparatively free from curls.

Known as the COPPY, plainhead and crested.

Cobby was an old Lancashire term for a crest.

The Cobby being the crested bird and the plainhead referred to as the Lancashire plainhead. Together called the Lancashire Canary.

The main characteristic of the Cobby is the straight up-right look. Training for this up-right position is required. Having several show cages lined up in a row, a piece of cardboard is placed between each cage in such a height that the birds can only see one another by standing at their full height.

Lancashire hens have a reputation of being indifferent mothers, They are very large birds, in need of a great deal of room to breed. With this in mind breeders tend to foster out their young to other canaries.

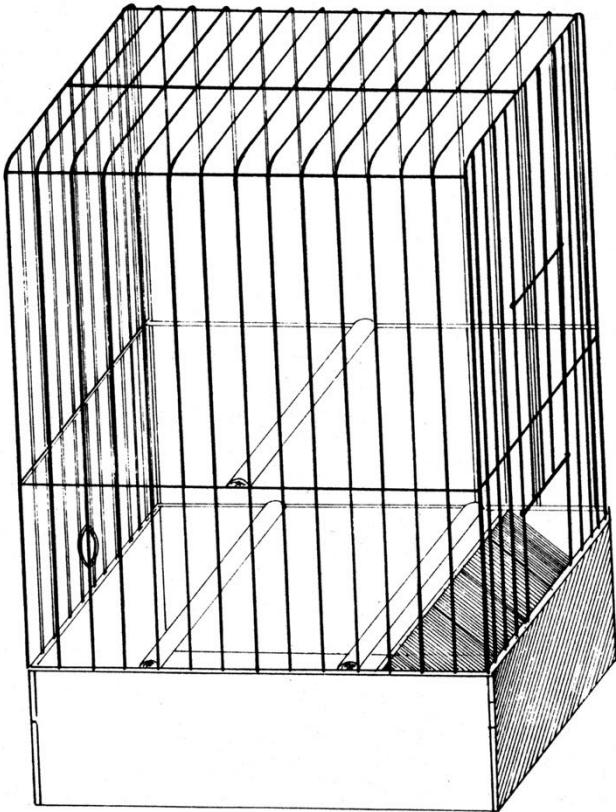

THE LANCASHIRE SHOW CAGE

## BRIEF HISTORY

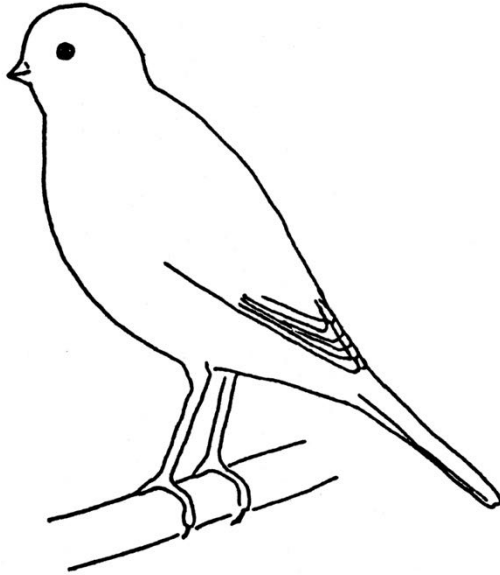

### THE FIFE CANARY

The Fife Canary is in fact a miniature Border Canary. The origin of the Fife Canary therefore would be the study of the Border Canary.

The breed was brought about through the disappointment of a number of Border exhibitors as their WEE GEM became larger and larger. At the National shows in the late 1950's the miniature class was recognized and formed. This new class was to be called the Fife Canary.

A meeting was called at Kirkcaldy, Scotland and there the Fife Canary club was formed.

In two or three years this canary's popularity grew and quite a number of shows in Scotland and England had good numbers of entries of the Fife Canary.

The scale of points in a bird show for the Fife and Border is practically the same, the main point of difference being that no bird can be considered a Fife Canary if it is over four-and-one-half inches from head to tip of tail.

The Fife Canary is a free breeder and the parents are very good rearing the young. They make a good variety for the beginner to canary breeding to start with.

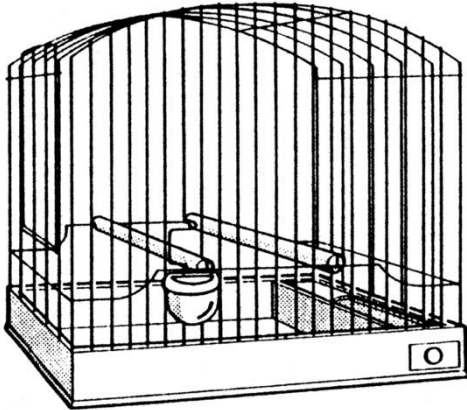

THE FIFE CANARY SHOW CAGE

## BRIEF HISTORY

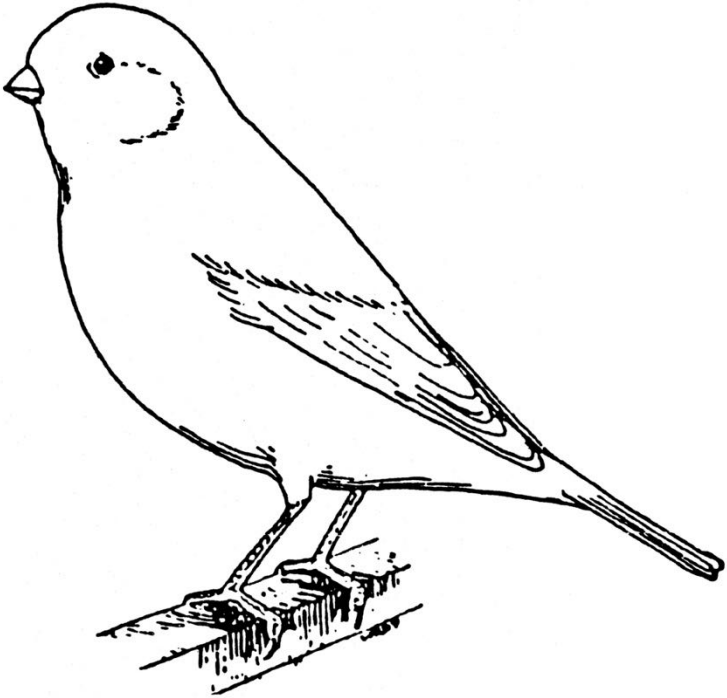

### THE NORWICH CANARY

The origin of the Norwich Canary goes back to the sixteenth century. The breed was brought to Norfolk, England by the Flemish weavers escaping persecutions by a Spanish aggressor. In those early days color was the main objective and a rich orange color was obtained by feeding cayenne pepper. As the story goes, this was discovered accidentally by a breeder who had a Norwich with a chill during the moulting season and thought that a little hot cayenne pepper might cure it.

In the 1930's this bird was bred with the Lancashire Canary. This breeding brought on size which there was a craze for at the time. Double buffing became the rule for size; this led to coarse and ragged feathers and feather lumps. Many breeders became disgusted and gave up keeping the Norwich.

In the late 1940's judges would disqualify any bird that had feather lumps.

A judge named A.W. Smith seeking to eliminate these feathery monstrosities cross-bred the Norwich with good-quality Borders. After a few generations he succeeded in producing a better type of Norwich which we have today.

Known as the JOHN BULL the Norwich Canary features are a good deep chest, a short broad back, compact wings, good carriage, a well packed short tail and a short neat beak.

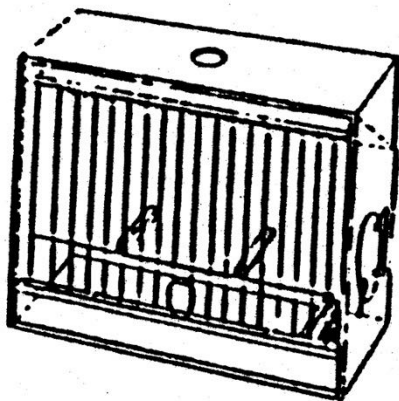

THE NORWICH SHOW CAGE

## THE FRILLED CANARY

It would be impossible to supply in this writing all of the information one would need to know if one was interested in breeding the Frilled Canary. Therefore, it is highly recommended that if you are interested in this unusual breed of canary, you contact and join THE OLD VARIETIES CANARY ASSOCIATION.

The most popular of the Frills are the PARISIAN FRILLS. The principal frilling is the mantle, jabot and fins. The NORTH DUTCH FRILL is often taken for a smaller version of the Parisian Frill. Unlike the Parisian too heavy frilling on the Dutch Frill is a fault. The frilling must not extend to the neck and head. The PADOVAN FRILL is best described as a Parisian with a crest. The MILAN FRILL is a colored canary. These attractive birds can be orange-red, white or in the blue form. The GIBBER ITALICUS Canary This bird is bred in yellow color only, The frilling on the Gibber is small and scanty, showing a naked breast bone and thigh. This is a distinctive characteristic of the Gibber; breeding stock is carefully selected for this reason.

There are a few more rare breeds of the Frilled Canary in the hands of very few breeders such as the JAPANESE MAKIGE, FIORINO, SWISS FRILL and the SPANISH GIBOSO.

The show cage for Frills is similar to the Lancashire show cage.

FRILLED CANARIES

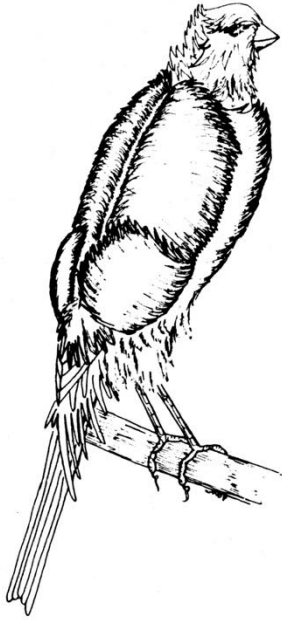

PARISIAN FRILL



DUTCH FRILL

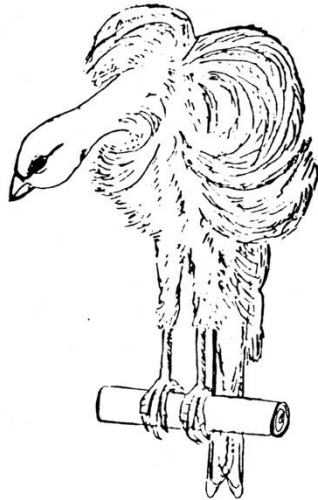

GIBBER ITALICUS

## COLOR-BRED CANARIES

To attempt to cover all aspects of breeding COLOR-BRED CANARIES at this writing would be impossible, but the information on the pages to follow may help the novice or beginner to understand the basic principles of breeding COLOR-BRED CANARIES.

It must also be noted and emphasized that the result percentages quoted on the following pages are what may be expected on the average. Having to cope with the mystics of genetic behavior, there is no guarantee of the outcome of the color desired. Some birds can be and are CARRIERS of genes that we cannot see in a selected pair of birds to be bred. Therefore, a breeder must accept what the birds being bred produce.

There are two groups of color-bred canaries. One group being the LIPOCHROMES and the other group being the MELANINS. The LIPOCHROMES are clear birds, the MELANINS are dark colored birds. See picture next page, the white bird being the LIPOCHROME and the dark bird being the MELANIN. Notice there are no bars or stripes running from head to the tail of the clear bird. All melanin canaries will have these bars or stripes. Some may be faint and hard to see, but after close inspection they will be present in a MELANIN bird.

The MELANIN bird will also have darker legs, beak and feet.

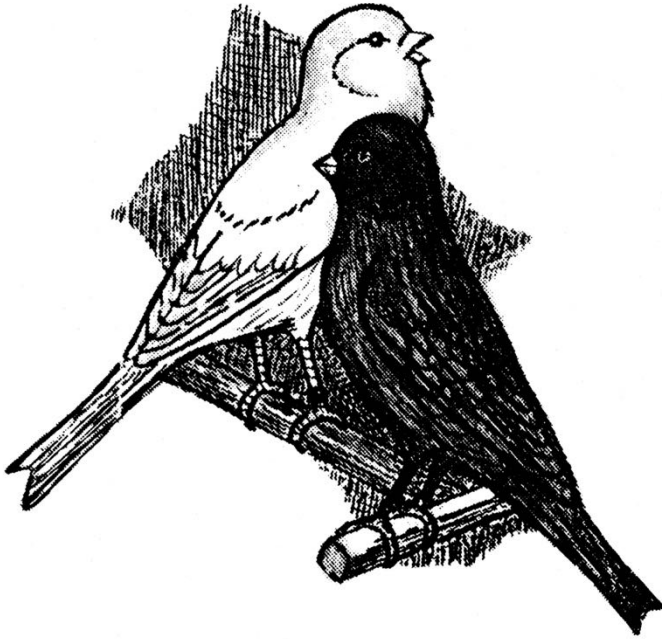

## LIPOCHROME AND MELANIN CANARIES

It must be noted that LIPOCHROME canaries can be ticked or variegated. Ticked and variegated is the portion of the feathers that are dark in color. Also, it should be noted that a MELANIN bird may have light feathers, usually in the tail; this is called a FOUL BIRD.

## SOFT FEATHER - HARD FEATHER

Depending on who you are talking to and what kind of canary you are talking about will determine the phrase you will use to describe the feathers on a canary.

When speaking with a TYPE canary breeder the phrase for describing the feathers on the bird would be YELLOW or BUFF.

If the same conversation was with a COLOR-BRED canary breeder describing the feathers on the bird the phrase would be FROST - NON-FROST or SOFT-FEATHER -HARD-FEATHER.

All of these phrases have same meaning. Confusing yes, just the bird jargon. For the sake of discussion in this writing I will use SOFT-FEATHER and HARD-FEATHER for description.

On a SOFT-FEATHERED canary the very tips of each feather will show white. The overall look of a soft-feathered canary will have a frosty or mealy look. Upon a close inspection, you will find a faint ring affect around the neck of a soft-feathered canary.

The HARD-FEATHERED canary will not show any white on the tips of the feathers. There will be no mealy look, but will show a deep, bright, rich color that will be level throughout the plumage.

With an experienced eye, the difference between a SOFT-FEATHERED canary and a HARD-FEATHERED canary can be distinguished at a glance.

In order to obtain good feather texture, when breeding canaries the pairs selected for breeding should be one bird a SOFT-FEATHERED bird and the other a HARD-FEATHERED bird. Sex can be either.

STANDARD OF PERFECTION  
OF THE  
COLOR-BRED CANARY  
As adopted by the  
Professional Bird Judge's Association

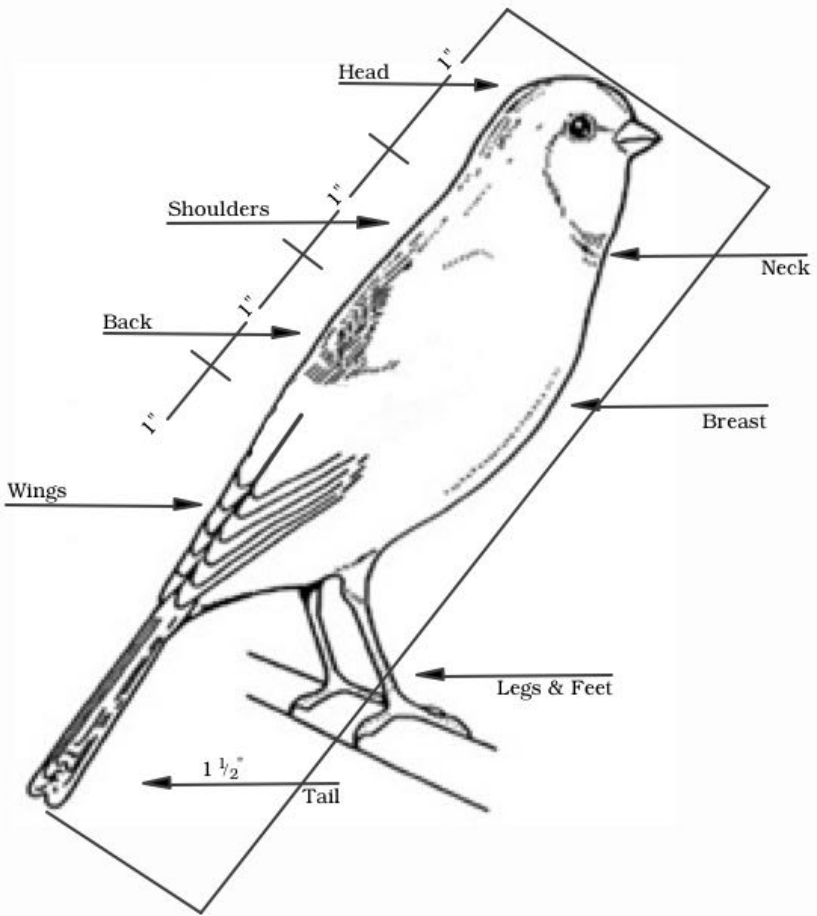

## A VARIEGATED CANARY



As far as where variegation will be positioned on the plumage of a bird will vary. The amount of variegation will also vary. It has been said, and at some shows the rule is, that if the variegation or dark spot on the bird can be covered with a dime, then the bird would be considered a clear bird.

When breeding variegated canaries, variegation will dominate. When a clear bird has been produced by mating two variegated birds, the color will be superior, very deep and rich in color. Variegation can pop up in all colors of the LIPOCHROME canary.

## LIPOCHROME COLOR-BRED CANARIES

We already know that LIPOCHROME canaries are those that are lacking pigmentation or (bars and stripes from head to tail). The following list of LIPOCHROME canaries can be either male or female and or hard-feather or soft-feather.

### RED GROUND:

Deep Red (clear).

Deep Red ( ticked or variegated).

Red Orange (clear).

Red Orange ( ticked or variegated).

### YELLOW GROUND:

Yellow (clear).

Yellow (ticked or variegated).

Yellow (rose Ivory).

### WHITE GROUND:

White (Dominant).

White (Recessive).

### MOSAIC OR DIMORPHIC:

Mosaic Red.

Mosaic Yellow.

### IVORY:

Rose Ivory.

Yellow Ivory.

## MELANIN COLOR-BRED CANARIES

Pigmentation (or bars and stripes running from head to tail) will appear in all MELANIN COLOR-BRED canaries. The study of MELANIN canaries is deep and prolonged. Here are some classifications of the study.

### BRONZE:

Deep Bronze.

Bronze Ivory.

### RED ORANGE:

Red Orange Brown.

Red Orange Ivory.

### RED ORANGE DILUTES:

Red Orange Agate - Ivory.

Red Orange Isabelle - Ivory.

### RED ORANGE PASTEL:

Bronze Pastel.

Red Orange Agate - Brown Isabelle.

### RED ORANGE OPAL:

Bronze Opal - Ivory.

Red Orange Agate - Brown Isabelle.

### YELLOW GROUND:

Green - Ivory - Pastel.

Gold Agate - Brown - Isabelle.

### WHITE GROUND:

Blue - Ivory - Pastel.

Silver - Agate - Brown - Isabelle.

con't

## OPALS YELLOW AND WHITE GROUND:

Green Opal.

Gold- Agate-Brown-Ivory-Isabelle.

Blue - Ivory.

Silver- Agate-Brown-Isabelle.

## SATINETT AND INO:

Rubino-Lutino-Albino Ino.

Red Orange-Gold-Silver-Satinettes.

## COLOR INHERITANCE IN CANARIES

The following information is by no means a complete work on the subject of color inheritance and mutations. It is hopeful that the reader will seek out articles in more detail in color inheritance and mutations in canary culture.

The color of a canary's plumage comes from two different sources, the food consumed by the bird and the coloring substances produced within the bird.

Depending upon its genetic configuration, the canary, like all birds, has the capacity to manifest certain colors. These colors exist in the basic unit of all living organisms, the cell. All cells have the same structure (the nucleus surrounded by protoplasm encased within a membrane). These basic units are responsible for specific functions in the reproductive systems of male and female bird. They bear thread like structures within called chromosomes.

In each chromosome there are units called genes. As a canary breeder we can pair birds for mating of the same color but because of the natural genetic behavior we do not have complete control of color in the offspring. So, we learn the basics and let nature prevail. Keeping the natural genetic behavior in mind, the following is a guide for pairing canaries for specific color percentage wise. Also, the CARRIERS of genes we cannot see have to be considered.

Mating Yellow to Yellow = 100% Yellow with some variegation.

Red to red = 100% red with some variegation.

Bronze to bronze = 100% bronze.

Green to brown = 50% green 50% brown.

There are two types of the white canaries the DOMINANT WHITE and RECESSIVE WHITE.

Mating dominant white to Yellow produce 50% white and 50% Yellow. Mating dominant white and recessive white will produce 100% white.

Mating dominant white to dominant white is not recommended as 25% of the young will be nonviable and will die.

Mating soft-feathered canaries to hard-feathered canaries will produce 50% of each.

To produce a blue canary, pair a green and a white canary. Once again it strongly recommended that you join a Canary Club for detailed information on pairing canaries for breeding.

## IN-BREEDING

What is in-breeding or line-breeding?

In-breeding is breeding from a small stock of closely related birds like father to daughter, sons to mothers, granddaughter to grandson and yes, brother to sister. Line-breeding is breeding from stock from distantly related birds like cousins or nephews. Obviously, genetic purity is more frequent and easily accomplished by in-breeding.

Now you will probably argue that breeding this close will produce weak, deformed and poor specimens lacking stamina. Unfortunately, this close breeding in human beings does cause these traits and leads to a condition called hemophilia. However, human beings do not cull the weak, deformed, mentally ill offspring like a breeder of birds would do. A bird breeder will keep only those birds that have good traits and cull out the birds with faults and sell them as pets or singers. You may realize by now that in-breeding is not for the novice. To achieve top quality canaries a breeder must be able to recognize all major faults the bird may have. These faults are spelled out in the standard of each canary. In-breeding is used more in breeding the Type canary than it is in breeding the color-bred canary.

Careful records must be kept of all matings in in-breeding. In-breeding is also used for song-bird breeding with Rollers and American Singers etc.

# LINE BREEDING CHART

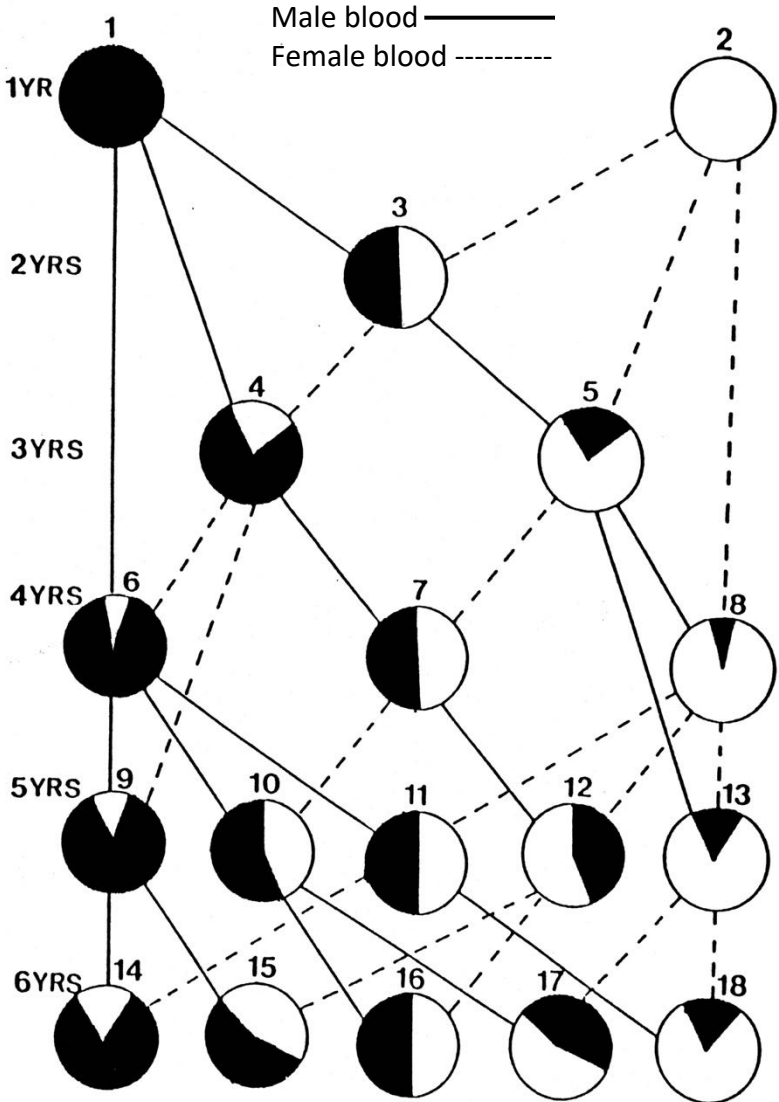

## COLOR FEEDING

"Color feed? Oh no! not me, I only feed my birds carrots and greens," said a divisional winner with a Red Factor canary at a bird show to a novice. Bologna!! With the exception of the Orange ground divisions, I doubt if any Red-Factor canary that has not been color fed, has won a division ribbon or trophy at any bird show in the Ü.S.A. for at least 30 years!

Several decades ago, canaries thought to be color fed were banned from entering bird shows. The great debate of those days was, what constituted color feeding? Some considered food such as carrots, fruits, vegetables and red pepper fed to canaries as color food. But wait...these are natural foods, so wouldn't these foods when fed be considered color enhancement? This issue was just a scrimmage between judges and exhibitors at bird shows, the war was yet to come.

The war really began when the artificial or synthetic coloring foods came on the market. Judges asked exhibitors, has this bird been color fed? Human nature being what it is, deception was common among exhibitors trying to get the edge. Deception became such a problem at bird shows, judges threw their hands up in the air in disgust and declared "let the reddest bird win." But yet even today with all of the coloring chemicals legal at bird shows you will still hear "oh no... I don't color feed my birds... I only feed greens."

## CANTHAXANTHIN

Canthaxanthin in its pure form, is the most powerful coloring chemical agent for color feeding Red Factor canaries. Feeding Canthaxanthin as a sole coloring food is not necessarily the best way. Canthaxanthin alone will cause the plumage to look, dull red. For a bright red look, Canthaxanthin mixed with Beta-Carotene half and half would be the proper ratio. This mixture can be mixed with the bird's water. The amount of this dry mixture would be  $\frac{1}{2}$  teaspoon to  $\frac{1}{2}$  gallon of warm water. Harm water will dissolve the mixture better. This mixture can be kept in the refrigerator and used when needed.

The same dry mixture can be added to corn bread. To a one-pound box of corn bread mix, add one teaspoon. Cook as you would cook regular corn bread. I add kernel corn to this corn bread, canaries love it.

It is most important that you start feeding color foods before the moult starts. If color foods are fed after the moult has started, some feathers will have a different shade than others, this would ruin the bird for exhibition. Most breeders that do exhibit their Red Factor canaries, color feed the year round. Exhibitors even feed the baby chicks color food while they still in the nest. This mixture of coloring food can easily be mixed with nestling food. You must keep Red Factors canaries away from other canaries while feeding this color food. This color food will turn a Yellow canary dull pink.

## COLOR ENHANCEMENT

Color enhance? Oh no! not me, I only feed natural foods to my birds. This time this statement could be true.

When speaking of color feeding canaries that are not Red Factors such as Yellows, Greens, Blues etc., color feeding or color enhancement can be accomplished without the synthetic agents. So, with non-Red Factor canaries you do have a choice.

First the synthetic agents. They are called synthetic carotenoids (yellow beta carotene for yellow ground birds).

These synthetic carotenoids are scientifically reproduced in a laboratory and have the same chemical structure as those found in natural sources.

When using the soluble powder form of the synthetic carotenoids, it can be administered to the bird's drinking water. Other methods are adding the carotenoids to corn bread. Added to jello with sugar, vitamins and minerals can also be effective. Make sure greens are fed when feeding synthetic carotenoids in the straight form so that the bird's diet will be supplied with enough vitamins and minerals. The dark leaf variety of greens is recommended, such as kale, spinach, dandelions or chard.

The second method of color enhancement for a non-Red Factor is, FLAMEN OIL. This product can be used with all canaries regardless of color and the color enhancement will be 100% natural.

## FLAMEN OIL

FLAMEN OIL is a blend of carrot oil and other wholesome vegetable oils containing D-activated animal sterol and natural carotene from carrots. The vitamin potency in each gram is 11,000 U.S.D. units of vitamin A activity in the form of carotene, and 3,600 international units of vitamin D; or, in each ounce, more than 300,000 units of carotene vitamin A activity, and 100,000 units of vitamin D-3.

Since this product is an oil, the method of administering would be, add 2 tablespoons of Flamen Oil to 1 pound of corn bread mix. Cook as you would cook regular corn bread. A large amount of this corn bread with Flamen Oil can be made and then frozen until used. Greens can be fed along with this mixture.

The advantage Flamen Oil has over the synthetic carotenoids is, synthetic carotenoids will not be absorbed entirely by the bird's system and will be excreted by a healthy bird. Flamen Oil will be absorbed entirely and therefore more effective.

Another factor that must be considered when attempting color enhancement in canaries is direct sunlight. In an outside aviary where canaries can have direct sunlight, there may be a bleaching effect causing a difference in the shade of color. Canaries that are kept indoors will have a deeper color intensity and you will have the edge on the show bench. Flamen Oil will not mix in water.

## SEXING CANARIES

How do you tell the difference between a male and female canary?

The only safe answer to that question is females lay eggs, males do not!

For a serious beginner that is interested in and wants to learn about canaries, this answer is just not enough. Some of the following methods are not good enough either, but some are.

Granted, there are some canary breeders with many, many years of experience that have the ability and a SIXTH SENSE to sex canaries from their looks and behavior patterns. Let's disassociate serious breeders from some following methods of sexing these very of the canaries.

Some methods can be very interesting, others are just entertaining. It has been suggested that the sex of canaries can be determined while the eggs still lay in the nest unhatched. Some eggs will have a sharper point on one end than others. These eggs will hatch out as males. The eggs having the more rounded ends will hatch out as females.



Figure 1.

The method in figure 1. would be useless if you didn't witness the hatching of the eggs. Witnessing the hatching of the eggs would be very unlikely when the hen insists on remaining on the eggs until all eggs are hatched out.

Another entertaining method of determining sex of young canaries while still in the nest is; the males will sit facing one direction, while the females will sit facing the opposite direction as shown in figure 2.



Figure 2.

Another method that has no scientific explanation, but some breeders swear by it is; the NEEDLE AND THREAD method and the NUT AND THREAD method. These two methods have the same principal, but a different application. An ordinary sewing needle is tied to 10 or 12 inches of thread. Holding the needle just above the head of the canary that is being held in the other hand, a rhythmic swing will begin. If the needle swings front to back (from beak to back of the head), the canary is alleged to be a male. If the needle has a cross the skull swing (eye to eye), the canary is alleged to be a female. See figures 3 and 4 next page.



Figure 3.



Figure 4.

The thread and nut method shown in figures 5 and 6 represent another unproven theory. Use a ¼ “ nut instead of a needle, tied to a piece of thread 10 to 12 inches long. Hold the canary in one hand while holding the nut and thread in the other hand, a rhythmic swing will begin. If the nut and thread swings from head to tail while holding it over the vent area as shown in figure 5, the canary is alleged to be a male. If the nut and thread goes in a circular motion, the canary is alleged to be a female as shown in figure 6.

Getting comfortable and having patience is the key when using the above method. Rest the hand you hold the thread in on a table. Hold the bird on your lap in the other hand. This will steady the procedure. Hold the nut about ½ inch above the vent area and have patience until it starts moving. Once the nut starts moving, the movement increases in time.

Incidentally the bow you see on the thread means nothing towards the experiment, it just indicates a piece of thread. I have personally tried this method on known male and female canaries. I have to report to you that my experience with this method was 95% accurate. I use a blue plastic split leg band for males and a red plastic split for my females. I sometime use this method and put these bands on the questionable male and on the questionable female. Later, if they turn out to be just that, the correct bands are in place



Figure 5.



Figure 6.

Continuing on with other methods of sexing canaries, the visible method may be the most popular among breeders. By blowing the feathers back away from the vent area, an inspection of the vent can be made. Similarity of the male and female vents may be present for most months of the year. Shown in figure 7, the vents of both sexes may be shaped alike. Until breeding season comes, then it's a different story.



Figure 7.

At breeding time, the male's vent area will change slightly. Compare figure 7 with figure 8. You will notice the protrusion will stick out at a slight angle, away from the base of the tail. At breeding time there is no question which canary is the female as figure 9 will show



Figure 8.

There is little or no doubt which canary is the female when breeding season is near. When the female is in breeding condition the vent area will be swollen. similar to the shape of a football. When comparing figures 7, 8, and 9, it will be obvious which canary is the female.

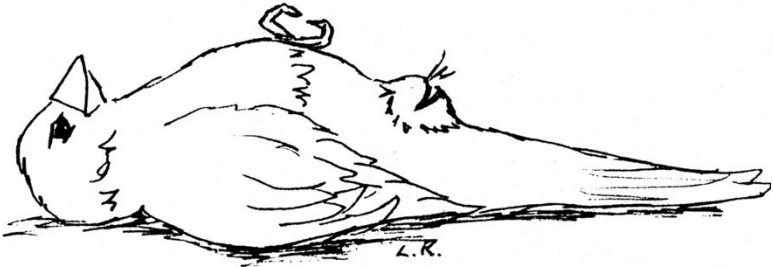

Figure 9.

Surgical sexing is financially impractical for sexing canaries. Also, the method of a laboratory analysis of the bird's droppings would be impractical financially for canaries. However, these methods are 100% accurate and when you have more expensive birds like parrots and other large birds, this method is probably worth it. The pelvic bone method of sexing canaries is meant for people with very sensitive fingers. You actually feel the pelvic bone near the vent area. If a separation or gap is felt by the touch of a finger, the canary is alleged to be a female. If no separation at all is felt with the touch of a finger, it is alleged the canary to be a male. As you can imagine, this method would take a lot of experience to master. I would say it is very inaccurate for canaries.

Last but not least, you may use the song as a method to determine the sex of canaries.

Don't be fooled, some female canaries sing, but they do not possess the quality of the male's song.

If you rely on the song as the sole source of sexing your canaries, wait until the young birds are at least 6 months old. Both young males and females have a baby song. They will sit around and sing a little chirping song. As the young males get older their song becomes longer and improves in quality. Net these potential singers, band them with a plastic split band. If they turn out to be female, no harm done. At a later date if the bird is a male, the split band of your color indicating males is in place. These males can easily be seen and picked out in your flock.

A good male singer leaves little doubt when being observed singing. Notice the throat. The throat will be full, the song will be loud, the wings will be dropped slightly and the song will be long.

The picture below is a good example of a full-throated canary singing.



## BIRDROOM ENVIRONMENT

Sometimes the bird room comes into existence when the kid marries or moves out on their own. Finally, the room gets a good cleaning!!

Basements make good bird rooms, and of course in moderate climate regions the outside bird rooms are popular and much easier to work with when it comes to providing proper ventilation.

Installing an exhaust fan in the roof of an outside bird room is very easy.

Installing an exhaust fan in a regular room in your home or the basement can be complicated. The exhaust fan most likely would have to go through a window.

Nevertheless, proper ventilation is very important. The air will become stale and stagnant, causing harmful fungi that may develop into a disease such as aspergillosis.

Given the problem of providing adequate ventilation in the bird room, especially during the winter when heating is required, the IONIZER may be the answer. Also, an ELECTRONIC AIR CLEANER will work as well. Whereas an Ionizer removes dust from the air onto a surface, the Electronic Air Cleaner actively cleans the atmosphere by removing dust and feather particles as well microorganisms, including mold spores, permanently. With these two devices warm air will not be lost from the bird room in order to improve the environment within. Watch for ads for these devices in bird magazines.

## ARTIFICIAL LIGHTING

Natural sunlight provides health benefits to all living things, whether it be plant or animal.

Unfortunately, not all canary breeders are able to provide direct unfiltered natural sunlight for their birds, so they turn to artificial means. For best in-doors results in breeding, moulting and other health benefits, the full spectrum fluorescent lamp called VITALITE ranks among the top of beneficial artificial lighting. Vita-Lite lamps are listed by the F.D.A. as an over-the-counter medical device. The light emitted by this tube compares well with that of natural sunlight. Vitamin D3 is very important in the health of canaries. The oil gland is located near the tail and is distributed and assimilated by preening. When the oil is exposed to ultraviolet light Vitamin D3 is produced. Vitamin D helps in the absorption of calcium used in the formation of eggs and bones. Malformations in beaks and soft-shelled eggs are caused by the lack of sunlight or of a source of Vitamin D.

Vita-Lites should provide the quality of artificial light canaries need and the tubes or lamps can be used in ordinary fluorescent light fixtures. Remove the plastic defusers and leave them off. These defusers will filter out what we hope to gain. Canaries should have at least 8 hours of rest each day without lights. Automatic timers for convenience can be installed.

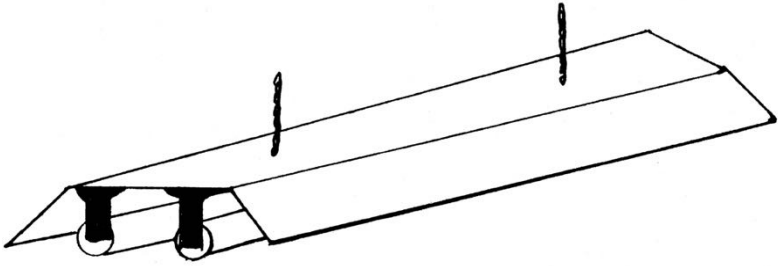

Vita-Lite lamps or tubes 4 feet in length can be used in ordinary fluorescent light fixtures.

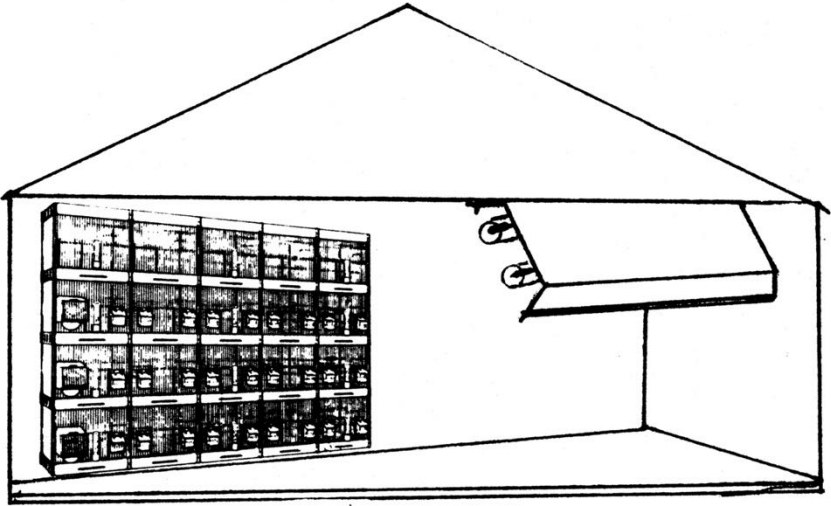

Mounting the light fixture on an angle on the overhead, will provide more light into breeding cages that are stacked against a wall. In order to do this, the ceiling would have to be at least 8 feet high for head room.

## NATURAL SUNLIGHT

If we are to achieve the maximum breeding condition in our canaries, we must obtain these conditions gradually. Even Mother Nature cannot do things overnight.

Having an outside aviary with several windows and sky-lights, will give you the advantage. Mother Nature can achieve conditioning our birds by natural changing of the length of day with natural light. Approximately 15 minutes is added on each day by nature.

Bringing canaries into breeding condition comes about by having the birds eat more. The more hours of the day the birds have to eat means more intake of food that will put them in the maximum healthy state for reproducing.

Having a tree where it will shade a portion of an outside aviary will keep the mid-day sun from over-heating the aviary. An exhaust fan on the roof will draw the hot air out and help cool the aviary.

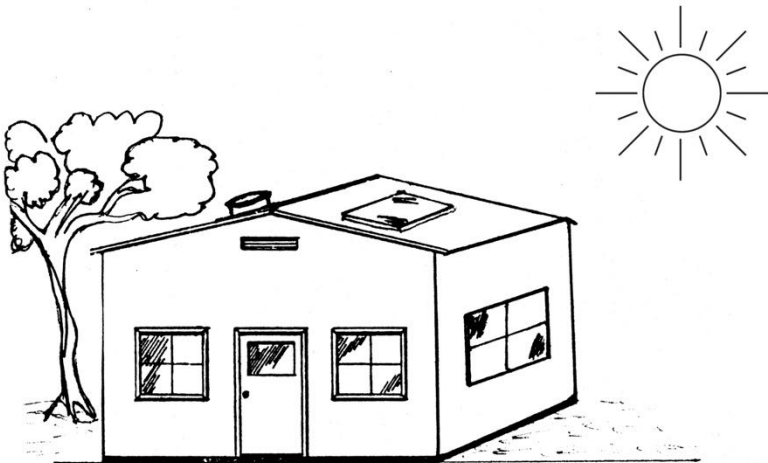

## THE SALE OF A CANARY

If you breed and raise canaries, sooner or later you will have to sell off some of your birds. Making room in your cages for the up-coming breeding season could be a reason. Birds that do not fit in your breeding program is another. Just simply having too many birds on hand, some have to go.

As a seller, above all, you must be honest to the buyer. Your responsibility as a seller is to deliver a healthy bird at a fair price. If you, as the seller, guarantee the sex of the bird, it should be of that sex. If the buyer is buying a singing canary, it should be a canary that sings. Always band your birds, as the band speaks for the age of the bird. If you, the seller fulfill the above, this should end the responsibility on your part.

The buyer also has responsibilities. The seller cannot be responsible for the bird's health once the bird leaves the seller's property.

The buyer should note how the bird is cared for. Note what size cage the bird is accustomed to and get a cage accordingly. Note what the bird is currently eating. If you change the diet of a bird suddenly, the bird will not eat and could die of starvation.

If the canary has been raised in-doors, the buyer should never put the bird outside in an outside aviary. In some areas the change in temperature is too drastic between day and night, the bird may not survive.

If your outside aviary is a mixed aviary, some of the larger Finches may kill a canary. Being a novice does not relieve the buyer from their responsibility of not knowing how to care for a bird.

If someone is selling canaries at a bargain price, they should not guarantee anything. The buyer buys the bird, as is. The buyer cannot expect any quality birds under these conditions.

Buying canaries by phone from far way places is not a good policy. You never know what you have until you return home from the airport. Chances are if you didn't receive what you ordered, you will not go to the expense of returning the birds. You may be stuck with what you received.

An honest mistake can be made by anyone. If you do make a mistake, admit it. Correct the mistake with the buyer and you will be remembered as a person that stands behind their mistakes. More sales will follow. Being honest is no doubt the best policy to follow. Being honest will even make you feel good knowing there will not be a repercussion from a sale of a bird.

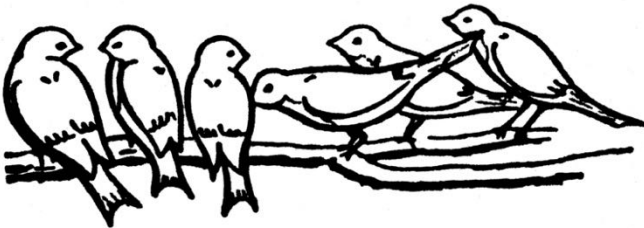

## SECTION FOUR

### CONTENT

THE CUTTLEBONE .....	97
CANARY SKELETON .....	99
PAMPERING CANARIES .....	100
HEAT LAMP .....	101
HOSPITAL CAGE .....	102
PAPAYA .....	103
GOUT .....	103
ALUM .....	104
STYPTIC POWDER .....	104
LEG BANDS .....	106
ALFALFA .....	107
GRIT .....	107
SPROUTED SEED .....	108
PERCHES .....	110
COMFREY .....	112
FLIGHT CAGES .....	114
CAGE ACCESSORIES .....	118
BIRD SHOWS .....	124
RECOGNIZING FAULTS .....	130
NATIONAL CAGE BIRD SHOW .....	135
CONDITIONING FOOD .....	136
NESTLING FOOD .....	137
QUESTIONS AND ANSWERS .....	138
SONG BIRDS .....	153

## THE CUTTLEBONE

That chalky and very familiar looking object we put in the cages with our birds is almost taken for granted, the cuttlebone. Where does the cuttlebone come from? Why is it beneficial to birds? What is the difference between a good cuttlebone and a bad one?

The cuttlebone comes from a cuttlefish. The cuttlefish is a creature of the Cephalopoda class and is related to the octopus and squid, and, in spite of its name, is not a fish at all. Different varieties are found in different parts of the world. The bone is actually an internal skeleton and is an excellent source of " calcium salts and trace minerals. This internal skeleton (bone) is honeycombed with gas filled chambers.

When the cuttlefish dies, the (bone) floats on the sea surface and in time is washed up on the shores, where much of it rots through contamination. This contamination can be caused by sewage, chemical reaction of decayed seaweed, etc. and repeated wetting by rain and sea water.

This indicates that cuttlebones, picked up at random on the sea shore, are often totally unsuitable for any purpose, and certainly not suitable for birds. Much of the bone offered for sale is collected this way.

The cuttlefish bone, that is suitable for birds and other purposes is that which is taken from fish caught for culinary purposes. The flesh of cuttlefish is considered a delicacy by natives in some tropical areas. This bone is clean, crisp and white and is not much more expensive in price than the rubbish that is collected from the sea shores.

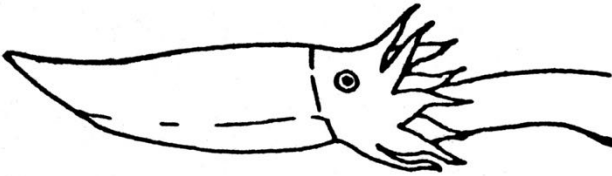

There is no question about the calcium in cuttlebone being beneficial to all birds kept in captivity. It is bone-forming and advantageous to the digestion. The bone contains antiacid properties and supplies some of the natural salts which are denied to birds kept in cages.

The addition of iodine keeps the bone in prime condition and has curative values that have long been recognized by medical profession in the prevention of goiters, tumors and other diseases that birds can contract.

Some tourists walking around a beach on the English Channel picked up some cuttlebone as souvenirs. What they had found remained a mystery until they arrived back at their lodging, where a cage bird enthusiast told them "that's cuttlebone."

## CANARY SKELETON

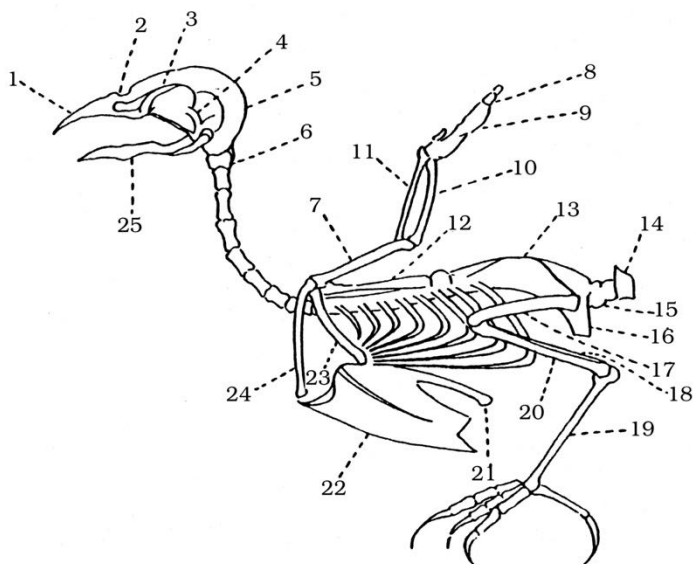

- |               |                |
|---------------|----------------|
| 1. Incisive   | 14. Pygostyle  |
| 2. Nasal      | 15. Ischium    |
| 3. Lachrymal  | 16. Pubis      |
| 4. Quadrate   | 17. Femur      |
| 5. Occipital  | 18. Fibula     |
| 6. Atlas      | 19. Metatarsus |
| 7. Humerus    | 20. Tibias     |
| 8. Phalanges  | 21. Patella    |
| 9. Metacarpus | 22. Sternum    |
| 10. Ulna      | 23. Coracoid   |
| 11. Radius    | 24. Clavicle   |
| 12. Scapula   | 25. Mandible   |
| 13. Ilium     |                |

As you look at the illustration below, keep in mind the next time you use a net to catch a canary, you are dealing with a very fragile creature made up of very small bones. Most injuries are to the neck and head. The skull of a canary is no more than paper thin. The neck bones (cervical vertebrae) as you can see are very small. Any bone in the body of a canary could be broken if you should strike the bird with the heavy wire that forms the round opening of the net.

## PAMPERING CANARIES

Do you pamper your canaries? If you do, good for you. If pampering your canaries is keeping your aviaries, cages, perches, food containers, floors etc. sparkling clean, feeding a fresh seed diet that is balanced, fresh water each day, you don't have to apologize to anyone, these are the bare necessities for having healthy birds.

I am sure you have heard the expression "you killing your birds with kindness," or per the jungle law, "let only the fittest survive." You should always remind yourself that you have your birds in captivity. The fittest bird alive when put in an aviary or cage will not remain the fittest or stay healthy if it is not taken care of properly. We are all guilty of caring less when "the new wears off. " A new car won't die, but a new bird will, if you don't pamper it.

Cutting corners when buying food for your birds, substituting something cheaper in quality for a cheaper price is not the way to go. It will be cheaper and more rewarding if you buy the best food possible and continue the practice. So, if you don't pamper your birds, why don't you start now!!



## HEAT LAMP

When you have a sick bird for whatever reason, keep the bird warm. If you do not have a hospital cage with controlled temperature, the next best thing could be a small cage and a heat lamp like the one shown below. A 75-watt bulb usually works fine.

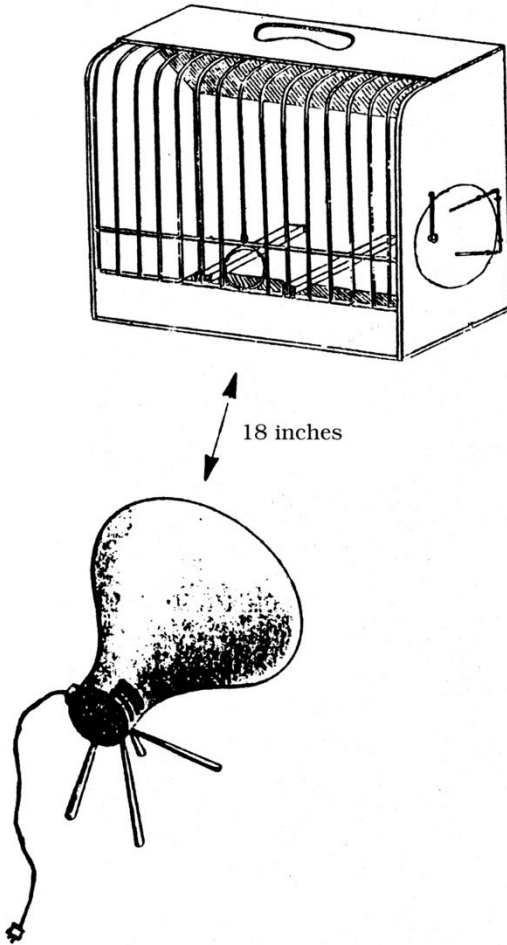

## HOSPITAL CAGE

Increasing the temperature to approximately 90 degrees speeds up chemical reactions in the bird's body, therefore allowing the bird's defense mechanisms to be more effective and this relieves stress.

Below is a sketch of a hospital cage. The ideal situation is to have a heat source with a thermostat that will turn heat on and off at a desired setting. Possible dimensions: length 24 inches, height 18 inches, depth 12 inches.

The heat source could be a light bulb with a ceramic base or a resistance strip with thermostat. These items can be purchased at MARSH FARMS.

Air enters the vent holes on bottom into the air space where it is heated. Then the warm air rises through vent holes in floor warming hospital cage area. The air then exits through vent holes in side. Arrows indicate flow of air. Consulting an electrician is advisable.

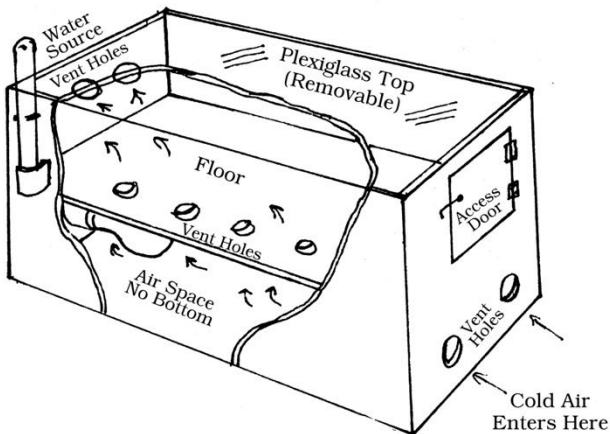

## PAPAYA

Papaya is an exotic health fruit of a small tree (*Carica papaya*) which produces its fruit continuously for three or four years and then dies.

The papaya has extraordinary powers to alleviate digestive disorders.

Papaya contains the enzyme papain which has the ability to digest protein and partially digest carbohydrates and fats. Many enzyme products made from papain are marketed and also prescribed by physicians for stomach disorders.

Papaya has iron, potassium, vitamin A, B, C. These are the elements you reach for when you are caring for less than healthy birds. Papaya has a pleasant taste and birds eat it with vigor.

## GOUT

Canaries can get gout from too much rich food. The feet and legs become swollen and turn red. This would be a symptom. Remember, canaries are seed eaters and do not do well with soft foods the year around. Consider anything that is not a seed, a soft food. Feed a steady diet of fresh canary, rape and niger seed mix. Feed a very small amount of greens every day or two. Have mineral grit and cuttlebone available at all times. Silver-Flight mix fortified with minerals and vitamins is a good balanced diet for canaries.

## ALUM

Alum is a safe, useful household product that can be kept around bird rooms and aviaries. This powder compound can act as a styptic when applied to a bleeding surface. Alum can be used for hens suffering from prolapsus of the vent. Application of Alum can be accomplished by using a Q-Tip or a cotton ball. A pinch of Alum added to the bath water will act as vermin destroyer.

## STYPTIC POWDER

When trimming toe nails on canaries, make sure there is a container of styptic powder nearby. Don't trim without it. As careful as you try to be, you will inevitably cut the blood vein in the toe nail while trimming the nails. By holding the toe between you and some light source, the blood vein can be easily be seen. Always cut the toe nail below vein. If you should cut the vein, you must stop the bleeding immediately. Styptic powder will stop bleeding immediately providing that pressure is applied to the wound.

Hold pressure for a minute or two. If the bleeding starts again, repeat the application.

Do not use styptic in deep wounds or body cavities or on burns.

The shock on the foot from landing on the perches could start the bleeding again. Keep an eye on treated birds for this reoccurrence.

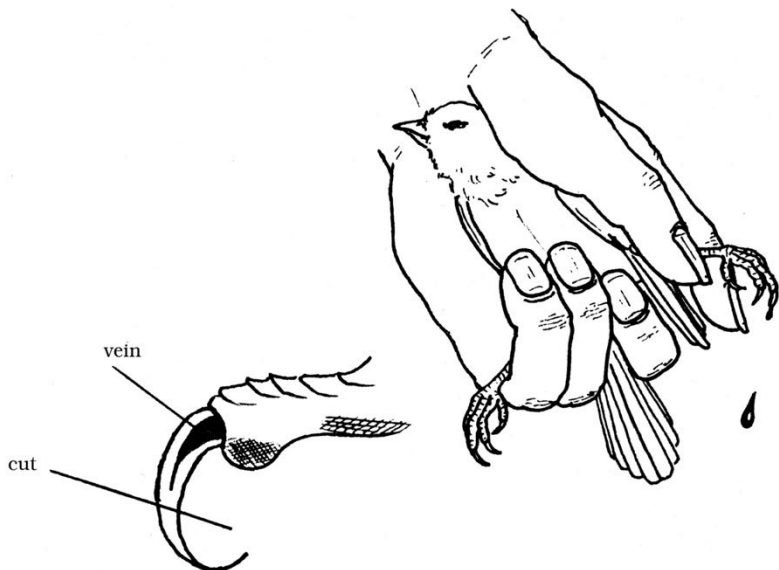

A canary that loses 6 to 8 drops of blood is enough to put the bird into shock and could cause death.

Using the correct scissors to cut toe nails on a bird eliminates the possibility of cutting off the toe next to the one you are working on. This can happen when using a regular pair of scissors.

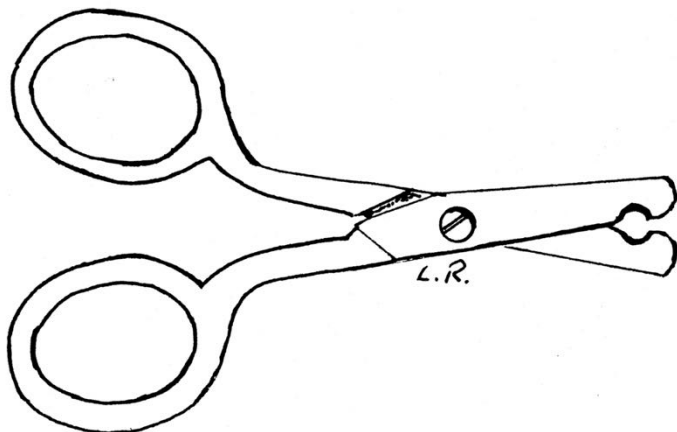

## LEG BANDS

Closed aluminum leg bands are used to band canaries for identification purposes. These leg bands can help you keep records of breeding and future breeding of certain birds with desirable traits. Closed leg bands must be put on a chick at about 7 to 8 days old. As the chick grows the band cannot be removed unless you have a special clipper to cut the band off the leg. Each band will have a number (1 to 100), initials of a co-op, bird club or your own. The band will also have the year the bird hatched. The year guarantees the age of the bird. The color of closed leg bands change each year. The open split leg bands are made of plastic, comes in several colors and they guarantee nothing. These open plastic leg bands can be removed at will. These bands are used mostly in identifying sexes or families. This is for the breeders benefit in sorting out birds. A split leg band expander is shown below. These expanders come with each order of bands.

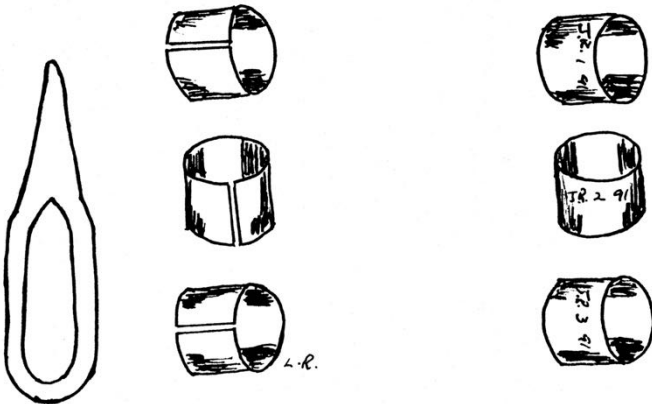

## ALFALFA

When you hear the word alfalfa, you think of hay, something that a horse or cow would eat. Birds like alfalfa as well, Alfalfa hay is loaded with cellulose, which is beneficial to canaries and for all birds. Alfalfa also contains vitamins and minerals. Alfalfa can be substituted for greens. It is wholesome and there is no waste. Alfalfa can be purchased in two forms. One form is in a fresh bale. The other form is in a cube. This cube is called a horse cube. The cube may vary in size, depending how the cubes break off in a wet, soggy condition from the manufacture's machine. The cubes are usually one and one-half inches in length and width. You will notice your birds eating more alfalfa around breeding time; alfalfa is a good conditioning food.

## GRIT

Some say that grit is not necessary for canaries. This is a matter of opinion. Feeding the correct grit, in my opinion, will not harm your birds. Sand from the beach is not a good grit to feed your birds. This would be the quickest way to give your birds an unknown disease. There are several different types of grit on the market. THE BLUE MINERAL GRIT, in my opinion, is the best one to feed your birds. Grit can be added to the seed mix. Your birds can eat it at will.

## SPROUTED SEED

Allowing seeds to sprout increases the food value by 100 percent. What started in the basic seed as a protein food turns out to be a nutritional food of minerals, vitamins, enzymes and vitamin C.

Sprouted seeds are especially beneficial when used in a nestling food. The mother will feed sprouted seeds before she goes for any other food. Some breeders would not feed without sprouted seed in the diet.

You must use seeds for sprouting that are free of chemicals. Seeds that have been fortified with minerals and vitamins will not sprout. The best place to purchase seeds for sprouting is a health food store.

Depending on how many birds you have to feed will of course determine the amount of sprouting seeds you need to have on hand at any given time.

Using the three jar method, will have sprouted seeds available each day. I use a quart jar with a screen over the opening of the jar for air supply and for easy rinsing. Rinsing is very important when sprouting seeds.

Using a quart jar 3/4 full of warm water, add 1/2 cup of seed mix. After 12 hours, drain water, add fresh water. Rinse seeds 3 or 4 times a day especially in warm weather. After 24 hours start a second jar, same procedure, then the third jar. Drain and rinse the first jar, do not add water, lay on side for the seeds to sprout.

Rinsing the seeds adequately is absolutely essential. Seeds will become rancid if they are not rinsed 3 or 4 times a day. After seeds have sprouted, keep in refrigerator, rinse each time before feeding to birds.

A possible mixture, equal amounts of:

Wheat.

Small black sunflower seed.

Safflower.

Canary seed ( straight).

Buckwheat.

Niger.

Rape.

Red millet.

White millet.

Mix well and keep in a cool place in a container with a lid until you are ready to make sprouted seeds. In cold weather seeds will take longer to sprout. Keep them in a warm place. Powdered minerals and vitamins can be sprinkled on sprouted seeds before feeding. Sprouted seeds can be fed at moulting time. Carrots, broccoli, spinach, etc., can be added to sprouted seeds.

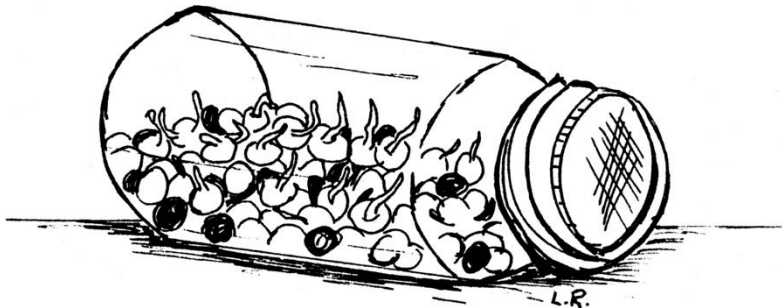

## PERCHES

Why don't birds fall off perches when they sleep? The musculature arrangement of the lower leg is controlled by a pulley system from the muscles at the top of the leg.

A series of tendons run from the muscles at the top of the leg, operating the leg with a series of ropes and pulleys. One of the most important of these tendons runs round the back of the ankle joint and into the toes.

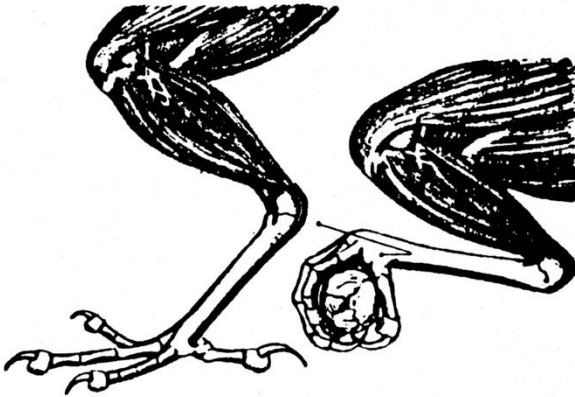

Note figure above. When the bird sits down onto its foot, the tendon is tightened over the end of the joint thus pulling in the toes. This action is particularly important in perching birds where the action of sitting down over the foot causes the toes to curl around the perch and lock the bird into position. By doing this, the bird can hold onto a branch tightly even when it is asleep. Indeed, it cannot easily let go of the branch in a sitting position, but must raise itself up off its feet in order to release the toes.

The muscles of the lower leg in birds are reduced for greater flying efficiency. In order to perch securely on a small branch or thin wire, a bird must be able to grip hard with its toes. This grip is applied when the leg is bent and the flexor tendons tighten.

When bird claws are left to grow long and irregular, it could restrict a bird from leaving its perch. Caged birds are always subjected to some type of wire. With this in mind, keep canaries claws trimmed. Twice a year is usually sufficient. To absorb some of the shock when a bird lands on a perch, a soft wood should be used. Birds also should have dissimilar sizes of perches to land on. An oval perch is available on the market. Round perches are more available and are most preferred. Doweling that you purchase in a hardware store is made of very hard wood; it should not be used.

The very end of limbs from small trees gives the bird various sizes to perch on.

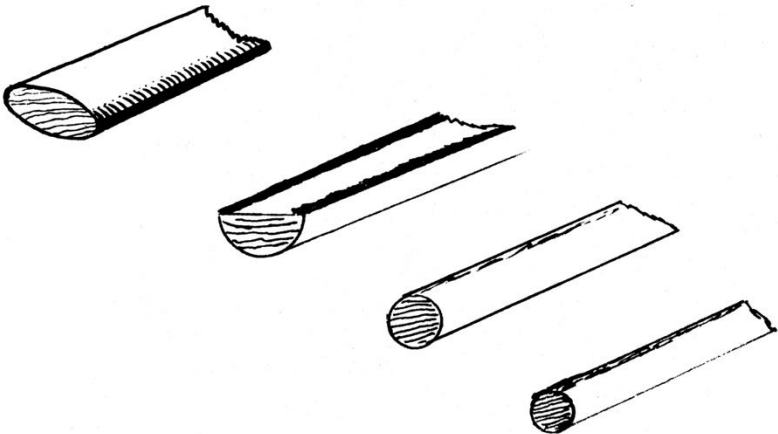

## COMFREY

The Comfrey plant, with its tall spike like stems and rough ovate leaves has been for centuries the world's fastest protein builder and herbal healer. This ancient plant was considered in the middle ages to be the perfect prescription for every sort of gastric disorder from indigestion to ulcers for humans.

Caged bird hobbyists found early on that this dark green plant discovery had noticeable health benefits for their birds when they added Comfrey to the regular feeding regimen.

Comfrey is one of the few vegetable sources of vitamin B-12. This vital vitamin is necessary for normal metabolism of nerve tissue and is important in protein, fat and carbohydrate metabolism.

Comfrey gets its high B-12 vitamins and other nutrients content by sending its roots deep into the soil. The roots of comfrey have been known to grow to 10-foot depths to gather these vitamins and minerals.

Comfrey is a hardy perennial that can grow nicely in nearly any type of soil providing it is keep moist. Once the root has established a foothold, it is rather difficult to eradicate. A green thumb is not mandatory to produce this herb.

The roots of Comfrey will spread rapidly when planted in the ground. You can start out with the smallest bit of root and end up with a sizeable patch of Comfrey in a couple of years.

Comfrey can also be planted in pots and be placed in a patio area where it will blend in with other flowers. Comfrey will produce a quite attractive flower of its own in the spring. These flowers are bell-shaped which can be white, pink or lavender in color.

There are two ways to implement Comfrey to your birds diet. Comfrey can be dried, crushed and sprinkled over seed. Since canaries are hardy eaters of leafy greens, just wash the leaves and feed them fresh.

Depending on how many birds are to be fed will determine the amount of greens you will feed. All greens gone in 12 or 15 minutes.



## FLIGHT CAGES

Size and shape when considering a flight cage for canaries is very important. Canaries like to fly horizontally: therefore, a tall round cage would be less desirable. I read somewhere that birds in a round cage do not feel safe because a round cage has no point of reference. You may interpret that any way you wish.

Providing you have the room and you would like for your flight cages to look nice and neat, you may consider constructing a flight cage like the one shown in figure 1. This flight cage is constructed as one cage but with a bottom for the upper half, it will become two flight cages. Picture the front of the cage in figure 1 as a full sheet of particle board 4' wide and 8' long. The holes with the rounded corners are cut out with a jig-saw. The ends and top are cut to your dimensions, I have these at 24" wide. The bottom of course will also be 24" wide and held in place with furring strips from underneath.

This cage could be built onto a wall with a corner where one wall becomes the back and the other wall becomes one end of the cage. This flight cage can also have legs with rollers to move the cage around. Wire for the front can be stapled from inside using the door for access. The cage can be painted to match its surroundings. Wood shavings can be used on the bottom. They can be vacuumed out periodically. This cage could become 4 cages if the front was laid out for such and a partition provided.

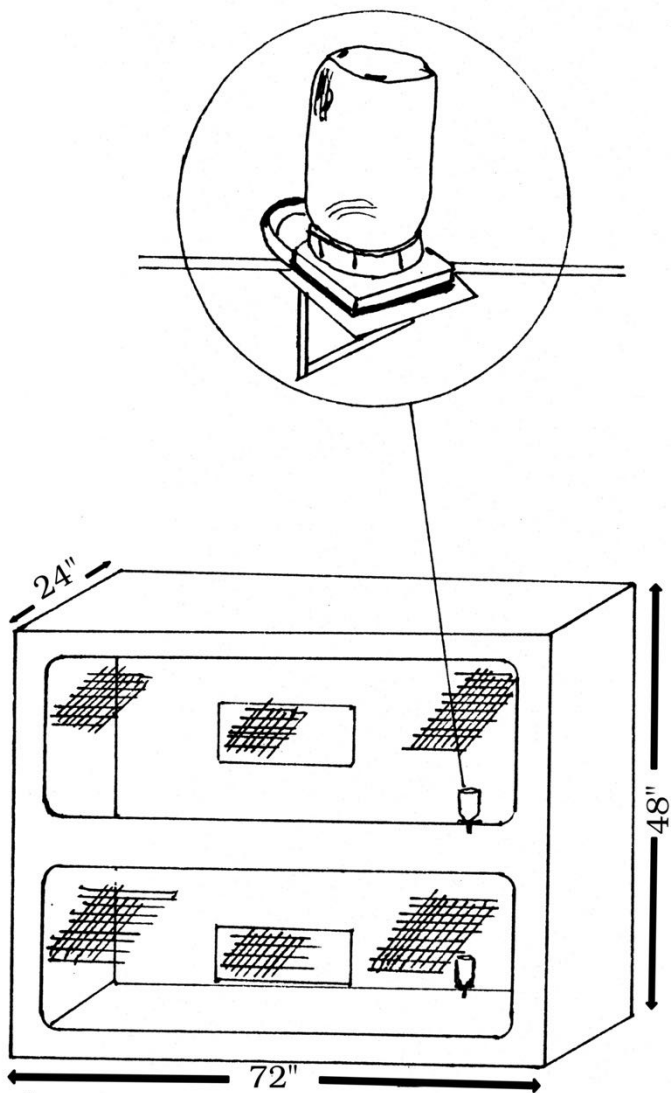

Figure 1.

Cages of this size could house up to 20 to 25 canaries. This would mean a substantial amount of drinking water would be in demand. A quart glass jar shown above would serve the purpose.

## FLIGHT CAGES

The wire that most cages that house our birds are made of is called WELDED WIRE. Welded wire comes in rolls usually 100 feet. The rolls of welded wire come in different widths, 24-inch, 36-inch and 48-inch. The width of the wire becomes important when determining the size of cage to be built. Welded wire can be obtained in hardware stores or in the larger seed and feed outlets.

Different sizes and types of welded wire are available. The size of spaces between wires can vary. The size of spaces in the welded wire shown in figure 1 is  $\frac{1}{2}$  inch X 1 inch. This is a popular size for canaries.

The cage in figure 2 could be of any size. A longer cage with a partition could serve as two cages. Pull-out trays or pans could be made of metal or wood. These type of cages are stackable where room is critical.

The most widely used device to hold this type of cage together is the cage clip or J- clip. They measure  $\frac{5}{16}$ -inch X  $\frac{1}{2}$  inch and are easily applied with the clip pliers shown in figure 3. The clips are applied to corners or any place where there are two wires to be fastened together to construct the cage. The clips can also be used as hinges for the door to the cage. Any door hinged at the top will never fail to close when let go.

A two-ounce fishing weight attached to the bottom of the door will add insurance that the door will close and stay closed.

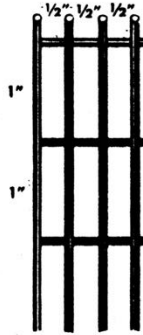

Figure 1.

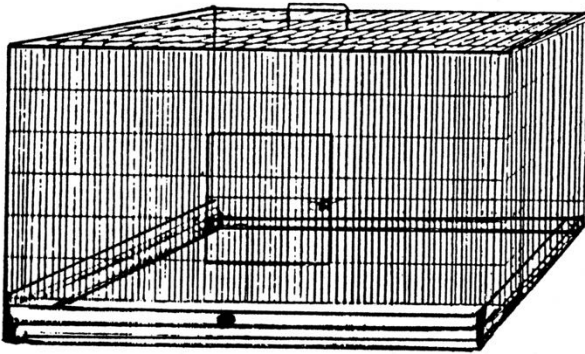

Figure 2.

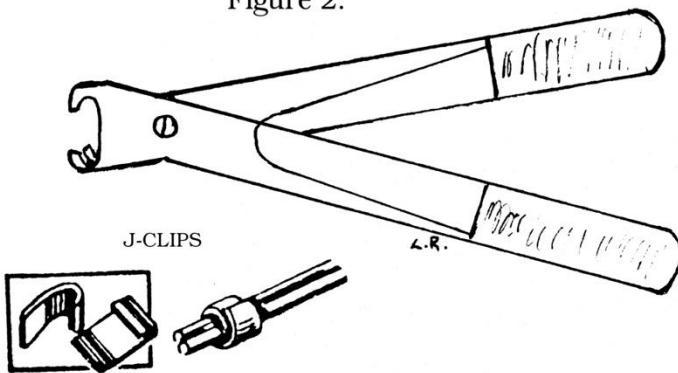

Figure 3.

## CAGE ACCESSORIES

Canaries are more settled in cages than some of the other species of birds. Canaries are not known as escape artists. An ordinary wooden clothes pin would work well holding a cage door secure. A door spring would work as well. An ideal quick acting latch that will leave no doubt when it comes to security is the RABBIT LATCH shown in figure 1. The latch looks complicated but once you hold the latch in your hand, the latch is self-explanatory by its spring actions.

## WATER DRINKERS

Figures 2, 3 and 4 are three of many water drinkers available. Figure 2, the tube drinker, is the most sanitary drinker of all. When there are a lot of birds to drink, figure 3 a 1-quart regular fruit jar fitted with a plastic bottom could be considered. This type drinker works well if it is mounted outside the cage with the plastic bottom portion extending through a hole in the wire. A platform will have to be constructed for this drinker to sit on. The drinker in figure 4 is totally unacceptable. Birds sit on the rim of this cup and defecate into the drinking water. Canaries would also bath in this cup.

## SEED CONTAINERS

Figure 5 shows an inside the cage container. Figure 6 shows an outside the cage container. For a small cage the container that fits outside the cage would be more appropriate; more room inside the cage. For average cages the container in figure 5 would do very well.

CAGE ACCESSORIES

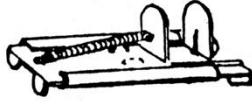

Figure 1.



Figure 2.



Figure 3.



Figure 4.

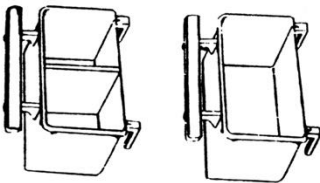

Figure 5.

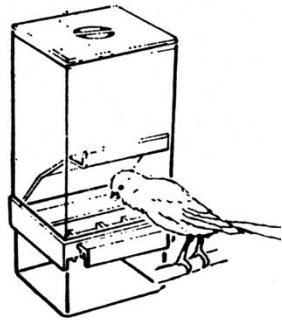

Figure 6.

In very large flight cages an old aluminum ice cube tray works well. The rims are rounded just perfect for canaries to perch on while eating seeds. The ice cube trays allow more surface area for seeds. Sometimes canaries will not eat if seeds are covered with husks.

A short but true story about the seed container in figure 1. on opposite page.

After buying a singing canary from me a young couple bought a cage with the type of seed container and drinker shown in figure 1 and figure 2. They both worked, the wife in the day time, the husband at night. They passed each other in the morning coming and going. They both would check the level of seeds and water in the see-through clear plastic containers each day. The canary always had plenty of seed and plenty of water. Their canary died. The husband called me and asked if I would come over to their house and see if I had any clue on how the bird died. When I arrived at their home which was near me, the dead canary was still on the bottom of the cage. I looked for birds droppings. You can tell by a birds droppings if the bird is ill. I found two very small droppings which was all dried up. No seed husks on the bottom of the cage. After a close inspection I found dry paper in the seed container. After further inspection of the seed container I discovered there was a big sunflower seed blocking the passage keeping any small seeds from dropping down. **THEIR CANARY HAD STARVED TO DEATH.** When you see someone using this type container for seed, tell them this story, you may save a bird's life.

## CAGE ACCESSORIES

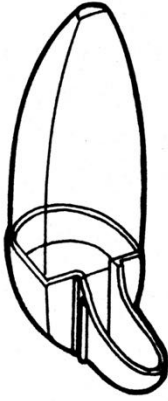

Figure 1.

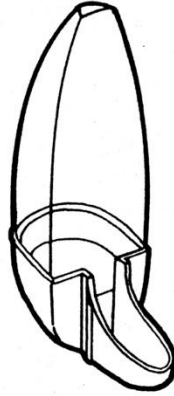

Figure 2.

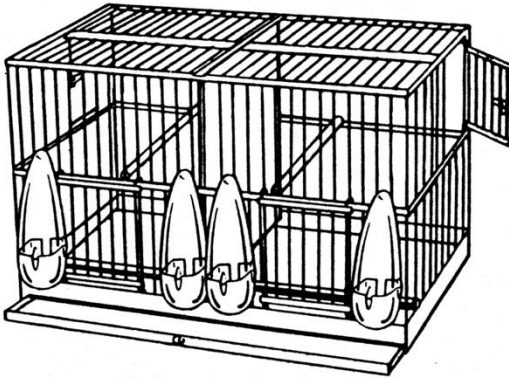
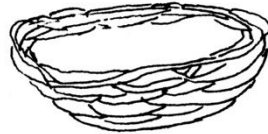
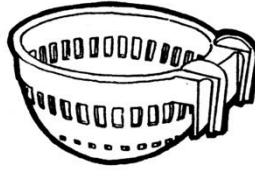
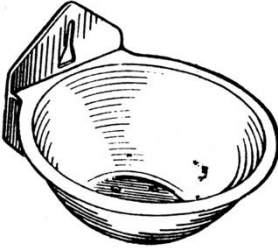

Figure 3.

The breeding cage in figure 3 comes complete with the type of seed containers that seed could clog in and become hazardous to your birds.

## NESTS



There are many different types of nests on the market. A few are shown above. See text on page 13 about nests.

Two nests that mount on the outside of the breeding cage.

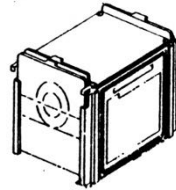

An information card holder or a defecation shield for wire and wood behind the nest.

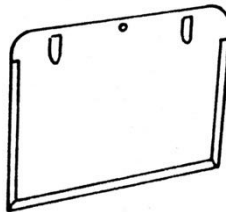

## BATH

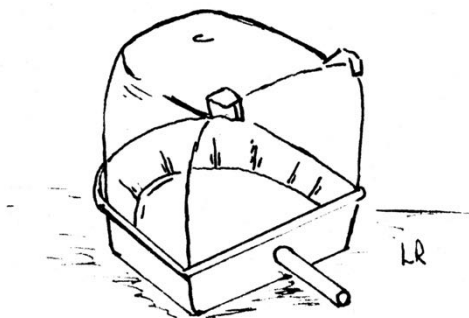

The above bathing dish is made to hang outside the cage. This bathing dish usually fits the door opening on a small cage. The perch has been added.

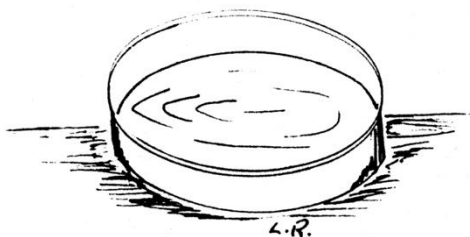

Most canaries will bathe daily if offered a container to bathe in. Canaries like a shallow dish or pan with no more than  $\frac{1}{2}$  inch of water. Canaries have the fear of drowning and will not go near a deep pan with a lot of water. Canaries will try to bathe in their water drinkers even if there is a bathing dish in their cage. Always change drinking water after canaries have had their bath.

## BIRD SHOWS

Indeed, a complete book could be written about bird shows. Rather than so much detail, let me attempt to mention some factors a novice would appreciate.

First, I would recommend to anyone who would like to learn more about their specific species of birds, is to join a club and attend the meetings on a regular basis. Most bird clubs compile and mail a newsletter to their members each month. Information, such as where and when birds shows will be held, will be published well before the event.

A few weeks before a bird show, most bird show committees make available a show catalog. This catalog has information one needs to know about the bird show. The catalog will contain when, where, hours open to public, raffles and sales. If you live in the area, (area sometimes defined as living in the county where the bird show is being held), you will be asked to enter your birds on Friday. Out-of-towners can bring their birds in early on Saturday morning as the judging usually starts at 10:00 A.M. sharp.

As an exhibitor you are expected to have your bird in the appropriate show cage and the bird classified and entered in the show correctly. A numbered cage tag is provided with information such as class, section and division that must

CAGE NO. 1127  
CLASS NO. \_\_\_\_\_  
SECTION NO. \_\_\_\_\_  
DIVISION NO. \_\_\_\_\_

---

NAME \_\_\_\_\_  
ADDRESS \_\_\_\_\_  
CITY \_\_\_\_\_

---

The cage number will already be on the tag when you receive it. A classifier will help you if you need help filling out the cage tag. After learning how to use the show catalog, the catalog will supply you with the information you need to know to complete the cage tag with the class number, section number and the division number. It is very important that all these numbers be correct. The numbers mean very little to you, but they are critical to the judge and his or her secretary for recording the results of winners.

The name, address and city portion of the cage tag is to be filled out by you the exhibitor. When completed, the lower portion below the dotted line is to be folded up over your name, address and city (use dotted line as a guide to fold). Two staples, one on each side, in place. Your name cannot be seen by anyone. After the judging is over, the staples can be removed and your name revealed. This system works well and avoids deception. The name tag will be tied to a wire on the bottom right side of the cage.

After your bird or birds are entered your birds become the responsibility of the bird show committee. in the show.

This responsibility is spelled out in the rules in the catalog. Read them and make sure you understand every rule and by all means abide by the show rules. On the show room floor is not the time nor place for you to try to change a rule. The proper time and place is your attendance at one of the bird show committee meetings for the up-coming year. If there is a change in some rule, it will occur at next year's bird show, not this year's show.

During the judging you may watch or better yet you may help with the judging. This is where you have an opportunity to learn all about the faults of canaries. Judges make comments as they judge. Volunteer your time to help the stewards; hardly ever will you be turned down by volunteering to help.

I have reservations about even mentioning the following, but I think it is important to determine the difference between a protest and a valid complaint. I certainly do not want this writing to suggest you have the right to complain or protest about everything that may occur at a bird show with which you may disagree.

Before you file a formal protest, get the attention of the judge's secretary or one of the stewards and discreetly ask for an explanation of your disagreement. You may have seen or thought you saw a ribbon being placed on the wrong cage; this can happen and does happen. Keep in mind that judges, secretaries and stewards are only human, that small lapses during a long day at the show hall will and do happen. A very conscientious judge will realize this and will take breaks to gather thoughts.

If a ribbon or rosette has been incorrectly placed on a cage. The secretary can tell you immediately because he or she has just recorded the cage number in the official records. A mere glance will reveal a mistake. The complaint can be rectified diplomatically without the shouting and waving of arms; that you would always be remembered and associated with such gestures. Another valid complaint that could be worked out with discretion would be: if you thought one of your birds didn't make it up to the judge from the staging area, the steward being at fault. Most judges have their special mark they put on the cage tag after they have judged the bird in that cage. Look for this mark to be sure.

Remember the judge is a professional and his or her decision is final. This is stipulated in the rules.

Registering a protest stating you think a cage is marked and the judge knew the owner of the declared winner is not a very good idea, unless you are absolutely positive about your facts. Avoiding a loud fuss also protects you, as it permits the show officials to reject your protest without making you look foolish.

Don't become one of these people that has to satisfy their big egos by buying canaries a couple weeks before the show entering them and sometime winning. You have exhibited another person's knowledge of breeding for quality. I would suggest to these people to go to a trophy store and buy your trophies and let the novice compete with other exhibitors that are sincere and devoted to breeding for quality.

On the following pages will seem to be a crash course for the novice and hopefully a refresher for the more advanced breeder.

As stated before, all canaries have a standard that a judge will judge toward. In this section faults of color-bred canaries will be pointed out. Remember the type canaries each have their own conformation and positions that they are to be judged for.

First let's start with the proper cage that color-bred canaries should be exhibited in. There are many folks that believe that too much emphasis is put on the cages canaries are exhibited in.

I have a tendency to agree with them. Almost all husbandry of the canary has been collected or inherited from the English methods. Being the devoted people, they are about their particular species of the canary, they lay claim that their species will show better in a cage designed by them. Other breeders will feel the same about their particular species. The controversy goes on until we end up with a different cage for each species.

The cage in figure 1 can be used to exhibit ALL color-bred canaries.

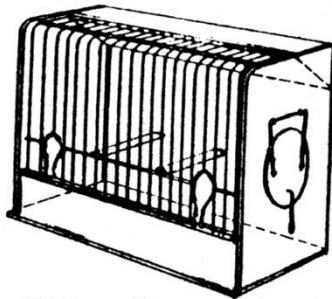

Figure 1.

The outside of all show cages are to be painted with a semi-gloss nontoxic black paint. The insides of show cages are also painted with a nontoxic paint. Different cages will be painted with different colors. The color-bred canary show cage in figure 1 will be painted inside with a non-toxic SURF BLUE., This background color shows the bird off really well. Some show rules state that two water drinkers will be placed on the cage. Rules in other locals may call for only one water drinker.

## RECOGNIZING FAULTS



The correct carriage of the wings, is to have them being held tightly close to the body and with the tips of the flight feathers in line and meeting each other neatly down the middle of the back.

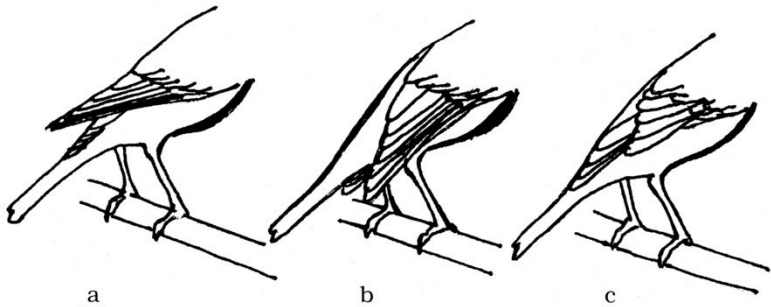

At the one extreme (a) wings may be so braced up as to cross each other at the tips or they may cross each other like a pair of scissors. (b) the wings may be held loose and slack, sometimes drooping below the tail. (c) shows displaced flight feathers. These are major faults in wings.

## RECOGNIZING FAULTS

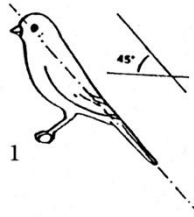

Standard of perfection.

Compare position and conformation of birds below with the bird above.

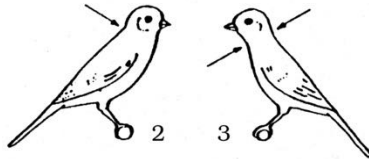

(2) Too much break of the neck. (3) Slim neck, chest not full or prominent.

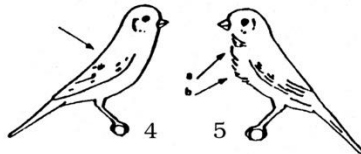

(4) Soft back. (5) Feathers rough, loose in appearance.

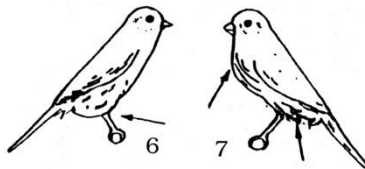

(6) Voluminous flanks (7) Bird too fat, bulky chest, round belly.

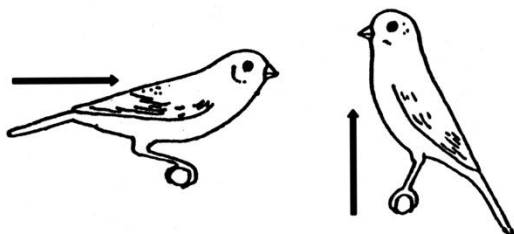

Bird on left, too horizontal. Bird on right, too vertical. Both bad.

Position is the way a canary presents itself in a show cage sitting on a perch. Position and conformation influence each other. Sharpness, stamina and calmness will make good position. A canary that is nervous, wild and moving around in the cage means lack of training. If a canary has been trained to a show cage for a couple weeks, the bird should settle down and show well. However, there are some canaries that will never be comfortable in a small show cage. Some canaries will sit on the bottom of the cage and will never perch. If the judge cannot see the bird on a perch, he or she cannot judge the bird. It is best to leave these canaries at home.

Always make sure the bird is clean and well groomed. Cut toenails about two weeks before a show. Sometimes the beak will grow too long and will have to be trimmed. Be very careful when trimming the beak. Watch an experienced breeder trim a beak before you attempt this yourself. Only put seed on the bottom of the show cage. Never put newspaper, the birds will tear the paper and make a mess of the cage. Make sure the door of the cage is taped closed. Use black electricians tape.

## BIRD SHOW DIVISIONS

The divisions listed below would accommodate any canary that may turn up to be entered in a bird show.

### DIVISION

1. Red Ground Hard Feather
2. Checked Frost
3. Red Ground Frost
4. Dimorphic Hen-Red Ground
5. Dimorphic Cock-Red Ground
6. Rose Ivory
7. Orange Ground Hard Feather
8. Orange Ground Frost
9. Dimorphic Hen-Orange Ground
10. Dimorphic Cock-Orange Ground
11. Yellow Ground
12. White Ground
13. Bronze Hard Feather
14. Bronze Frosted
15. Red Orange Brown (Cinnamon)
16. Dilute (Agate)
17. Red Orange Isabel (Cinnamon Dilute)
18. Red Ground Pastel
19. Red Ground Opal
20. Yellow Ground Melanin
21. White Ground Melanin
22. Yellow or White Ground Pastel
23. Yellow or White Ground Opal
24. Satinette, Ino, Topaz
25. Red Factor Topknot
26. Non Red Factor Topknot
27. Border
28. Gloster Corona
29. Gloster Consort
30. Norwich
31. Norwich Crest
32. Yorkshire
33. Columbus Fancy - Crested
34. Columbus Fancy - Plainhead
35. Lizard
36. Parisian Frill
37. Northern Dutch Frill
38. Southern Dutch Frill & Gibber
39. Belgium Fancy
40. Scotch Fancy
41. Fife Fancy
42. Canary Crosses



## NATIONAL CAGE BIRD SHOW

Bird shows are held by the hundreds all over America each year, but the grand-daddy of them all is the National Cage Bird Show.

Moving to a different city each year, the National offers the two most prestigious awards which bird breeders and exhibitors in America treasure and contend for. The Kellogg Trophy is awarded to the exhibitor that has Best Bird in the division of that species. There are 12 divisions of birds in the National. These 12 divisional winners will compete for the Best Bird in the show. The winner will be awarded the Scannell Trophy; there is only one Scannell Trophy awarded each year.

I can relate to you from my own personal experience that being awarded both of these most sought after awards in one night is just overwhelming.

The year was 1988, San Diego, Ca. the first National Bird Show I ever attended. The winning bird was a Toco Toucan and the first time the Toco was ever shown in a bird show. The win, I was informed later, was the first time a Toco Toucan was awarded a Scannell Trophy for being the Best Bird in a National Cage Bird Show.

I mention this grateful moment for me for two reasons. First, I am very proud of the fact that I was awarded these two awards and that I would encourage you to enter your birds in a National when the opportunity is at hand.

## KELLOGG AND SCANNELL AWARDS



### The Kellogg Trophy

The Kellogg Trophy is generously donated by The Kellogg Seed and Supply Co. The Kellogg Co. has provided trophies for the first and for every National since 1949. It is awarded for the Best Bird in Division.



### The Scannell Trophy

The Scannell Trophy is also donated by the Kellogg Co. This prestigious award is the most sought after award in American birddom.

## CONDITIONING FOOD

As stated, before you must condition your canaries before you attempt to breed them. The following formulas are just a few that are proven and work well.

### Conditioning Food:

1 cup minute rolled oats.

1 cup Gerbers dry mixed cereal.

1 cup dry plain bread crumbs.

1/3 cup dry plain gelatin.

1/3 cup wheat germ flakes.

1/3 cup dry powdered milk.

Feed dry. Store in dry place. This food will not become rancid or spoil, it contains no egg food or wheat germ oil.

### Conditioning Food:

2 tbsp. bread crumbs.

1 teaspoon wheat germ flakes.

1 grated hard-boiled egg.

Mix well. Feed twice a week. Increase quantities to suit your needs.

### Conditioning Food:

1 cup dry egg food (CeDe or Abba 92).

1/4 teaspoon of avi-cultur 1 billion.

1/4 cup distilled water.

15 drops Oce Fitol.

15 drops Oce Vit.

20 drops Oce Choline.

Mix above ingredients well and add two grated hard-boiled eggs. Feed twice a week. Adjust amount per number of canaries you are feeding.

## NESTLING FOOD

Do not be confused between conditioning food and nestling food. Nestling food is food baby chicks eat. You must offer the hen something she likes in order for her to feed the baby chicks. Try the following.

### Nestling Food:

2 cups dry bread crumbs.

1 grated hard-boiled egg.

1 small grated carrot.

1 teaspoon (Enfamil or Simlac).

1 teaspoon powdered cuttlebone.

Mix well and offer moist twice a day.

### Nestling Food:

2 cups plain bread crumbs.

2 cups ground Arrowroot baby cookies.

3/4 cup dry powdered milk.

2 teaspoons dry vitamins.

Mix well. Make fresh daily. Use 3 teaspoon of this dry mix to 1 hard-boiled egg.

### Nestling Food:

2 cups bread crumbs.

4 cups Gerber Hi-Protein baby cereal.

15 crushed Arrowroot cookies.

12 tbsp. powdered milk.

2 tbsp.

4 tbsp. plain gelatin.

Vionate vitamins.

Mix well. Mix 3 tbsp. of this dry mix to 1 hard-boiled egg. This formula can be frozen.

## QUESTIONS AND ANSWERS

This section of this book will be made up of questions and answers. Questions that are frequently asked at bird club meetings and other bird related functions.

### **DO CANARIES HAVE TO LEARN TO SING ALL OVER AGAIN AFTER THE ANNUAL MOULT?**

As you may or may not know, some male canaries continue to sing even though they are in the middle of their moult. To say that all canaries have to learn to sing all over again after the moult would be too broad and suggestive. However, after close note of some of my canaries, it was noted that at the end of the moult the song in the beginning was not loud and complete, but soft and short. The song became longer and improved in quality as days went by.

### **HOW DO CANARIES GET VITAMIN D?**

One half hour a day of fresh air will supply your canaries with enough vitamin D. If you house your canaries without natural light and open windows, you can supply the necessary vitamin D by adding vitamin D to the birds food.

### **WHAT CAUSES THE LOSS OF FEATHERS AROUND THE NECK AREA OF A CANARY?**

The loss of feathers around the head and neck could be caused by a diet deficiency or feather lice. For feather lice, mix (4) parts Witch Hazel to (1) part Listerine. Lightly spray bird until damp. Repeat in (3) days.

## QUESTIONS AND ANSWERS

### WHAT ARE THE FIRST SIGNS OF CANARY POX?

The first signs of canaries having canary pox are lesions on the feet, legs and around the head

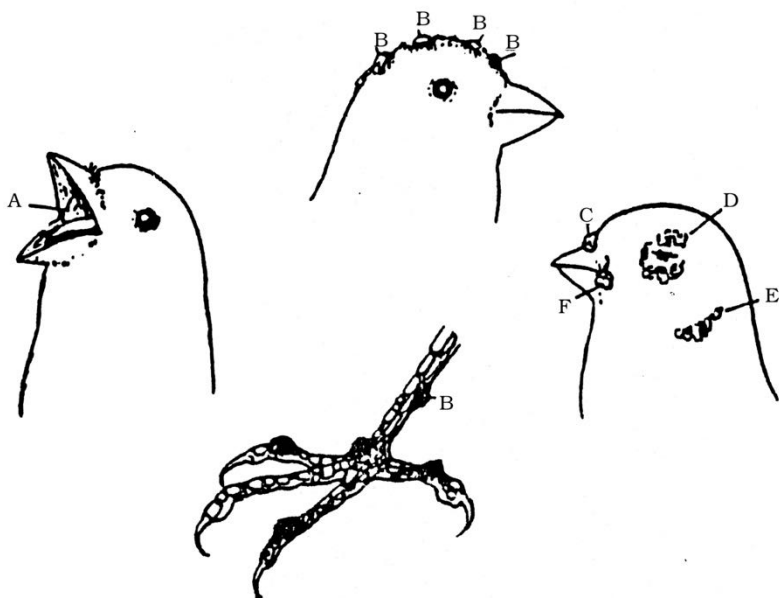

area. See below.

- (A) Mouth Lesions.
- (B) Tumors on legs, toes and head.
- (C) Nose infection (yellow scabs).
- (D) Eye abscess.
- (E) Ear infection (yellow scabs).
- (F) Mouth infection.

These conditions will only get worse and will eventually cause death if left unchecked. It is recommended that a veterinarian be consulted

at this stage of canary pox. Remove these birds from others - canary pox is contagious.

## QUESTIONS AND ANSWERS

### **WHAT IS MEANT BY A SWEATING HEN?**

Since birds are unable to sweat, this term is somewhat inaccurate. The term SWEATING HEN is used in England to indicate an unhealthy condition in a nest of chicks. Instead of being clean and fluffy the chicks are damp and messy usually caused from diarrhea. The hen is unable to keep the nest clean in the normal way by removing the fecal sacs.

### **CAN CANARIES TALK, OR WHISTLE SONGS?**

For convenience I installed a phone in my bird room. This touch phone has a high pitch in the ring. On several occasions I have answered the phone just to hear a dial tone. In time I learned one of my canaries learned to mimic the phone ring. Amusing but frustrating.

I once read in MAYI HELP YOU article by Margie MaGee in American Cage Magazine that a lady wrote "I believe my canary is saying pretty boy." The lady claimed the canary picked up the sound from a Parakeet. Another lady wrote she had taught her canary to do tricks and that the bird could whistle Yankee Doodle.

### **SHOULD PREVENTATIVE MEDICATION BE USED?**

I am sure you have heard the expression, "an ounce of prevention is worth a pound of cure."

## QUESTIONS AND ANSWERS

Not necessarily when it comes to medication and your birds.

It is recommended that you do not give medication to a healthy bird as a preventative or a safety measure. Never give medication unless the bird is sick or has been directly exposed to a dangerous contagion.

Giving your birds medication regularly will not prevent trouble, but will probably cause trouble. Medication will destroy the immunity that a healthy bird has. Medication given to a well bird will eventually give you a weak and sick bird. If I may use the expression again "if it is not broken, do not fix it."

### **WHY SO MANY CLEAR (INFERTILE) EGGS?**

Even the experts cannot explain why hens lay eggs that are not fertile. Some breeding seasons there will be more clear eggs than others. Blame has been placed on every aspect of the breeding program. Most breeders agree that if you feed your birds the correct diet the year round and condition the hens before attempting to breed, that is about as good as it gets in prevention of having a lot of clear eggs. Having fed an abundant supply of wheat all year prevented clear eggs for one breeder, but it didn't work for the breeder the next year. Try as we may, we still have to take what our birds give us. Some breeders believe that the weather has a bearing on eggs being fertile or infertile.

## QUESTIONS AND ANSWERS

### **WHEN SHOULD THE BREEDING SEASON BEGIN?**

The weather where one lives may dictate the start and the ending of a breeding season. A hen should never be allowed to go to nest if the incubation period will run into the moulting duration.

Be familiar with the start of warmer weather in your area. Considering only taking two clutches from any one hen, one can count backwards 4 weeks for each clutch from the date you consider the weather will start to warm up. This may give you an idea of when to start the breeding season. For those who have controlled heating, lighting and other ideal conditions, one might breed canaries almost at will. Don't get greedy and work the hen for 3 or 4 clutches. If you do get greedy, your hen will have a short life.

### **WHAT IS A SAFE AND QUICK WAY TO BRING A DOWN - AND - OUT BIRD AROUND?**

Try ½ teaspoon of Black Strap molasses in a tube type drinker of water. Also, a Brewer's Yeast tablet in a tube type water drinker will help. The Black Strap molasses will also stop loose bowels.

### **WHAT CAN BE DONE TO HELP EGG BINDING?**

Keep the bird warm 85 to 90 degrees. Apply oil around the vent area. A muscle relaxant called Octin dissolved in a teaspoon of warm water given orally will help.

## QUESTIONS AND ANSWERS

### **WHAT IS MEANT BY ( CHECK FROST)?**

First, we have the HARD-FEATHERED bird that will show no frost at all at the tips of the feathers. Second, we have the SOFT-FEATHERED bird or frosted bird that will show white at the tips of the feather. The CHECK FROST bird will look like a HARD-FEATHERED bird, but if you look real close you will find tiny white tipped feathers especially around the neck area. These tiny white tips are more apparent on a Red-Factor canary.

### **WHAT SHOULD ONE LOOK FOR WHEN BUYING A CANARY?**

Look for a closed leg band that will indicate and guarantee the age of the bird. Ask if you can hold the bird in your hand. By putting the bird close to your ear, you can determine if the bird has a respiratory problem. A canary has a respiration rate of 90-140 breathes per/min. A canary with a respiration problem will have heavy breathing sound or rasping sound. A clicking sound may indicate air sac mites. Check for missing toes and toe nails. Eyes should be clear and dark. Check feathers for mites, feather lumps and cysts. If purchased as a singer, the bird should sing after a reasonable time at your home. The environment in which you see a bird presently living could determine your purchase of a bird.

## QUESTIONS AND ANSWERS

### **SHOULD I PUT MY CANARIES ON PELLETS AS A COMPLETE DIET?**

Remember canaries have always been seed eaters. There seems to be a big push on pellets for all birds. To answer a question with a question, are we giving up natural foods for the convenience of the pellets?

### **WHAT IS A NOVICE?**

A novice is an exhibitor who has never won a trophy.

### **WHEN BREEDING CANARIES WHICH BIRD WILL CONTROL THE SIZE, MALE OR FEMALE?**

The male controls the size, the female controls conformation.

### **SHOULD I GIVE MY CANARIES COD-LIVER OIL?**

Cod-liver oil can become rancid very quickly after the bottle has been opened. Allow your canaries to get oil they need by feeding seeds that have natural oil such as rape, niger and sunflower seeds.

### **MY CANARY DROPS FEATHERS ALL THE TIME, WHAT CAN I DO?**

Canaries that continually lose their feathers are in a soft moult. A soft moult means your canary is subjected to too much heat all the time. If you keep your canary inside your home, in the kitchen, or close to a window where they receive the heat from cooking, or from heat bouncing off

the glass from the sun, your canary will continually moult.

**WITHIN A BREEDING SEASON WHY ARE THERE MORE MALES THAN THERE ARE FEMALES?**

No theories or hard rules have been established for this, but it is true that 2/3 of chicks in a breeding season will be males.

**MY CANARIES WILL NOT DRINK THE THAT I HAVE ADDED MEDICATIONS TO WATER**

Most medications have a very bitter taste. Use Tang or orange juice instead of water. You also are adding vitamin C to the mix.

**SHOULD I GIVE MY CANARIES CHARCOAL?**

Charcoal does nothing for canaries.

**SHOULD I FEED CUCUMBERS TO MY CANARIES?**

Yes, cucumbers are especially good to feed during the moult. Cucumbers are high in nitrogen, phosphoric acids and potash, picked up from soil improvements such as commercial fertilizers and animal manures. Cucumbers can be fed the year round.

## QUESTIONS AND ANSWERS

### **WHERE CAN I ORDER MY CLOSED LEG BANDS?**

If you join a specialty canary club, they usually offer closed, traceable leg bands.

### **I READ SOMEWHERE THAT FEATHERS EVOLVED FROM SCALES, IS THIS TRUE?**

The study of fossils found by Paleontologists proved that the earliest known bird ARCHAEOPTERYX was half reptile and half bird. The archaeopteryx had both scales and feathers. This led to the conclusion that 150 million years ago in the Jurassic age feathers as we know them today did in fact evolve from the scale. This evolution from scale to feather, gave this ancient reptile the ability to fly. From this flying reptile evolved the bird as we know them today.



## QUESTIONS AND ANSWERS

### **WHY DO HENS ABANDON THE CHICKS AFTER THE CHICKS HATCH?**

There can be many reasons for abandonment. Some hens never make a good parent. These hens should not be used. If the nestling food is not tasty to the hen, she will not feed the food to the chicks. Sometimes if the male is left in the breeding cage, the hen may be scared that the male will harm the chicks, so that she will not leave the nest for food. The male will feed the hen, but no food is offered to the chicks.

The inexperienced and over-anxious breeder can cause abandonment. If a hen is repeatedly pushed off the hatching chicks by curious fingers or hands, the hen may surrender and vacate. This abandonment would be from her natural impulses.

A hen could be frightened off the nest at night by a sudden noise. If there is no light to guide the hen back to her nest, the chicks will get cold and will be too weak to eat the next day. Hens will abandon weak and sick chicks.

Mice will scare a hen off her nest and will bring about the same results.

Some breeders prefer a second-year hen for breeding. They claim that the first-year hen is just not mature enough to nourish and care for the young.

## QUESTIONS AND ANSWERS

More on abandonment of chicks.

Abandoned chicks can be fostered out to other hens or, believe it or not, fostered out to males. Some males make excellent foster parents, but please, know your birds.

I would recommend to any breeder to have in your breeding room two or three Green hens for foster parents. Green canaries are closely related to the original canaries found hundreds of years ago by the Spaniards. The green canary is superior, in my opinion, to other canaries when it comes to nourishing and raising the young.

Even a green canary will not foster a chick on command. Having a willing foster hen has to be done by design. One would have to condition these special birds like all other breeding hens. They have to go through the breeding cycle as all canaries do. You may have to sacrifice their eggs to save other chicks that have been abandoned. Breeders that put several hens to nest at the same time have the advantage of saving the chicks that have been abandoned by a hen. The green hens will be ready and will accept the chicks. If possible, transfer the chicks to the foster parent a couple hours before lights out. You can hide if possible and watch to see if she feeds them. Also watch to see if she sits in the nest. Chances are good she will accept the chicks if her scent is on the chicks the next morning. Removing all perches will force the hen to sit on the rim of the nest. The natural instinct of nourishing will prevail.

## QUESTIONS AND ANSWERS

### **WHAT WOULD CAUSE ALL CHICKS TO DIE IN THE NEST OVER-NIGHT?**

There could be many reasons; starvation, disease, not the fit of fittest, incorrect diet and sour food.

Another responsible reason could be the infestation of the red mite. The red mite is a blood sucker. This mite only comes out at night. If the infestation is critical, red mites can take enough blood from a nest of young chicks over night to kill all chicks in the nest. The breeder never sees the villain because by morning the villain has gone back to the crevices and the hen gets the blame.

The red mites presence can be ascertained by the all chicks in the nest.

powder-like substance, their droppings, which is generally found in the crevices where they stay during the day.

To check for red mites, place a white cloth over the cage at night. Check during the night. If red mites are present, you will clearly see them on the white cloth.

In warm weather these mites multiple rapidly. These pests can be destroyed with a liquid insect spray and the cages should be thoroughly washed and disinfected. Allow a couple of days for disinfectant to dissipate, If possible, put cages in the sun for a few hours.

## QUESTIONS AND ANSWERS

### **WHY DO HENS PULL THE FEATHERS FROM THEIR OWN CHICKS?**

Some say that hens pull feathers from their chicks for material to build another nest. After taking a careful look at new nests being built, I see no nests lined with feathers taken from young chicks.

Not only will the hen pull the feathers from the chicks, she will also pull the new quills as they grow out of the skin. The hen will nibble and work the quill or feather around with her beak as if she is getting a substance from the quill. Could it be protein or the mineral salts they get from these young and tender feathers and quills? Regardless of the reason for feather plucking, the young chicks will have to be separated from their parents. This can be accomplished by a partition within the cage or by hanging a smaller cage with the young onto the cage that house the parents. The parents will be able to feed the chicks through the wires as shown below.

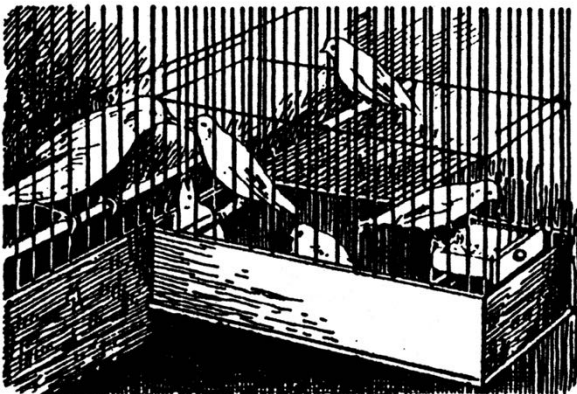

## QUESTIONS AND ANSWERS

### **HOW MANY MALE CANARIES CAN BE HOUSED IN ONE CAGE WITHOUT THEM FIGHTING?**

This will depend on the temperament of the birds. Some males are territorial and will not allow any other male close to them.

Another factor will be the size of the cage. I have flight cages that are 6 foot in length. I have no problems with 8 or 10 males in cages of this size.

### **HOW MANY DAYS OF INCUBATION BEFORE YOU CAN CANDLE EGGS?**

After 8 days of incubation is enough time to check for fertilization. It is not necessary to remove the eggs from nest to candle. By using a Flexi Lite light (shown below), you can bend the neck and place the light against an egg and determine if the egg is fertile. If light shows through the egg the and looks clear, the egg is not fertile.



### **WHERE CAN I GET A RECIPE FOR A MINERAL BLOCK FOR MY CANARIES?**

Most mineral blocks on the market are too hard for canaries and other finches. Here is a basic recipe you can work with. Plaster-of-paris is the hardening element. Try adding less of the plaster-of-paris than the recipe calls for.

## QUESTIONS AND ANSWERS

Recipe for mineral blocks:

2 cups plaster-of-paris.

1 tablespoon calcium phosphate.

1/4 teaspoon iodized salt.

1/4 cup blue mineral grit.

1 tablespoon of trace minerals.

Trace minerals can be obtained from a veterinary supply house. The calcium phosphate can be purchased from a pet shop or supply house.

Mix the above ingredients with just enough water to make a very thick paste. The mixture is then poured into ice cube trays until it starts to set up. While it still soft, bend a piece of wire into a (U) shape. Place the wire down in the center of the cube. After drying hard, the wire will make it possible to fasten the mineral block to a wire cage. Make sure blocks dry completely before using.

### **HOW IMPORTANT IS RECORD KEEPING?**

Keeping records is important and is recommended. The amount of information you may keep will depend on you. There is a saying "knowledge breeds success", but if you do not have quality canaries to breed, all the knowledge in the world will not bring quality offspring.

### **WHAT IS MEANT BY OUTCROSSING?**

Outcrossing is bringing in a stud from outside your line in order to improve some point which is lacking in your own line.

## SONG BIRDS

Ever since 1478 when the Spaniards landed on the shores of the Canary Islands, as they are known today, the native bird of those islands has been most widely known and loved for its spirited and melodious song. the canary,

There are four major types of song birds.

Three of these, the GERMAN ROLLER (or the Hartz mountain canary), BELGIAN WATERSLAGGER and the SPANISH TIMBRADO are recognized in internationally competition. The fourth type, the AMERICAN SINGER is a relatively young breed which originated in the mid-western United States and to date participates in National bird shows.

The oldest of these birds is the German Roller canary. The Roller canary originated in the Hartz mountain region of Germany and was carefully and selectively bred by a population of about 400 families of miners in the region as a diversion from hard life of mining ore. Over hundreds of years, a bird was developed which sings what is today considered the most refined and controlled song of any canary. The song is typically very low pitched and soft. The song is composed of various combinations of song sounds known as tours. The birds compete alone or in teams of four and they undergo extensive training by tutor birds from where they learn their various tours by imitation.

The BELGIAN WATERSLAGGER hails from Belgium as its name implies. It has a song with some resemblance to that of the Roller, but with

added "water notes" which are sounds that mimic bubbling, plopping and rolling water among others.

This bird's song has tremendous variety and thus it is quickly gaining in popularity in Europe as a singer that is inferior to none other.

The SPANISH TIMBRADO is a breed originating in Spain as is suggested by its name. It is a bird that is much like its wild ancestor in that it is basically, green in color. It is a friendly and rather non-excitabile bird which sings a sweet high-pitched song of tremendous variety and stylistic quality.

Keeping within the rim of basics at this writing, I hope there is enough mentioned here about these song birds, that you, if interested, will seek out more information on these extraordinary song birds.

#### SONG BIRDS ON A LIGHTER SIDE

If you were a native of Brazil, you would probably own a bird or two, or three, or maybe dozens. Brazilians are nuts about birds. Caged birds are a common sight in homes, stores, garages, dry cleaner's shops and even on the street. "It is like a virus" said one bird owner, "if you don't have a bird singing in your house, you don't feel well."

All over Brazil bird owners gather in courtyards, city squares, schools, anywhere they can compare notes and give their birds strenuous vocal exercise. They gather on Sundays, hundreds of cages hanging from trees, on the roof of cars, while they talk and drink beer. They

claim if you leave your bird at home the bird becomes mute or heavy-voiced and sad, but when they are taken out and see other birds, it starts a little war between them. A war is what the owners want.

You see there are singing tournaments. The dream of every bird owner, of course, is to have a tournament winner. First there are regional tournaments; if your bird wins a regional, he has a chance to advance to the national championship. If your bird becomes a national champion, the bird becomes almost priceless.

One of the most popular birds for its song is the CURIO. His song is said to be like a violin. The Curio's larger relative the BICUDO called "the bird of the elite," however can out sing the Curio in a singing tournament. While the Curios sell for \$150 to \$2500, the Bicudos can command far more.

Although it is illegal, the big winners are taken from the wild from nests as baby chicks and raised in cages. In some cases, bogus leg bands are put on captured birds, making their sale appear legal. This creates a black market, but enforcement by law officers is rare.

To a stranger, these birds may seem ordinary, but to their owners their distinctive personalities make them objects of intense love and affection. A sales director for a Volkswagen franchise at a singing tournament in Rio de Janeiro said. "I sold my best Curio to a friend to pay some bills. My friend's wife said to me if I left a new car in her garage, I could have my Curio back. I did. Now I would not sell him at any price. He is going

to be a champion one day." People flock by the hundreds to listen to the sing-offs. The singing noise is non-stop. It is remarkable that the judges can even distinguish which bird is singing. But the judge's ears are trained. A good Bicudo should offer 300 songs in 25 minutes. The most on record was 350 songs in 25 minutes. The contest begins. Any bird not singing is eliminated. A bird that does not sing 50 times in ten minutes is eliminated. In the finals the birds are allowed 15 minutes to sing. The bird that sings the most songs wins.

The most recognizable man you will see at a sing-off tournament is Noir Puline Martins. Martins is an institution in Brazil, he is the owner of many champions singers. A few years ago, he sold his taxi license, took one of his champion singers named CLOUD BREAKER, into a recording studio, hung the bird cage in front of a microphone and recorded, THE PARACAMBI SONG OF THE CURIO, the avian equivalent of a learn-a-language tape. Martins peddles his records and tapes from the trunk of his car. " I have sold over 40,000 records and 10,000 tapes" he says, "people come all over to buy them." Martins uses his record to teach his own most promising young Bicudo named PRINCE OF THE FORESTS to sing. "He's 18 months old, still too young to be a tournament bird," Martins says, "if you offered me \$10,000 for that bird, I would not sell."



## INDEX

### **A**

Abandonment Of Chicks .....	147
Alfalfa .....	107
Alum .....	104
Air Sac Mites .....	38
Artificial Lighting .....	92

### **B**

Banding Chicks .....	18
Bath .....	123
Belgian Canary .....	50
Beneficial Seeds .....	8
Bird Shows .....	124
Black Strap Molasses .....	142
Blue Egg .....	26
Bird room Environment .....	91
Border Canary .....	46
Breeding Canaries .....	9
Breeding Cages .....	12
Building The Nest .....	15
Bumblefoot .....	40
Buying Canary .....	143

### **C**

Cages For Canaries .....	3
Cage Accessories .....	118
Candling The Egg .....	28
Canthaxanthin .....	80
Charcoal .....	145
Check Frost .....	143
Chicks Leaving Nest .....	20
Color Bred Canary .....	68
Color Inheritance .....	75

## INDEX

Color Feeding .....	79
Color Enhancement .....	81
Colony Breeding .....	13
Comfrey .....	112
Conditioning Food .....	136
Crested Canary .....	48
Cucumbers .....	145
Cuttlebone .....	97

### **D**

Diet For Canaries .....	6
Divisions In Bird Show .....	133

### **E**

Egg Binding .....	26
-------------------	----

### **F**

Faults – Conformation .....	130
Feather Lice .....	35
Feather Lumps .....	42
Feather And Scales .....	146
Fife Canary .....	62
Flamen Oil .....	82
Flight Cages .....	114
Formation Of The Egg .....	22
Fostering Out Chicks .....	14
Frilled Canary .....	66

### **G**

Going Light .....	7
-------------------	---

## INDEX

### **H**

Hand Feeding .....	19
Handling The Egg .....	27
Hard Feather .....	69
Heat Lamp .....	101
History Of The Canary .....	1
Hospital Cage .....	102
Housing Canaries For Breeding .....	12

### **I**

In-Breeding .....	77
-------------------	----

### **K**

Keeping The Nest Clean .....	20
------------------------------	----

### **L**

Lancashire Canary .....	60
Leg Bands .....	106
Lipochrome Canaries .....	73
Lizard Canary .....	58
Loss Of Song During Moulting .....	138
Loss Of Feathers .....	138

### **M**

Males And Females .....	145
Melanin Canaries .....	74
Mineral Block .....	151
Monogamous Hen .....	29
Moulting .....	32

## INDEX

### **N**

National Bird Show .....	134
Natural Lighting .....	94
Nests .....	13+122
Nesting Material .....	14
Nesting Food .....	137
Norwich Canary .....	64

### **O**

Outside Aviaries .....	3
------------------------	---

### **P**

Pampering Canaries .....	100
Papaya .....	103
Pellets .....	8+144
Perches .....	110

### **Q + R**

Questions And Answers .....	138
Red Mites .....	36+149
Reproduction System .....	23

### **S**

Sale Of A Canary .....	95
Scaly Leg Mite .....	37
Separate Hens From Males .....	13
Sexing Canaries .....	83
Sick Birds .....	43
Signs Of Copulation .....	15
Skeleton Of A Canary .....	99
Slipped Claw .....	31

## INDEX

Song Birds .....	153
Sprouted Seeds .....	108
Starting The Breeding Season .....	142
Standard Of Color Bred Canaries .....	71
Styptic Powder .....	104
Sweating Hen .....	140

### **T + U**

Tang .....	145
Tassel Foot .....	41
Toe Nail Scissors .....	105
Type Canaries .....	45
Unfertilized Eggs .....	141
Unflighted Birds .....	31

### **V + W + Y**

Variegated Canary .....	72
Vitamin D .....	138
Weaning The Chicks .....	21
Whistle Songs .....	140
Worms .....	44
Yokers .....	17
Yorkshire Canary .....	56



WILD CANARY – *Serinus canarius*